

## AV Receiver

# *TX-SR505*

# *TX-SR505E*

# *TX-SR8550*

# *TX-SR575*

## Instruction Manual

Thank you for purchasing an Onkyo AV Receiver. Please read this manual thoroughly before making connections and plugging in the unit. Following the instructions in this manual will enable you to obtain optimum performance and listening enjoyment from your new AV Receiver. Please retain this manual for future reference.

## Contents

Introduction ..... 2

Connection ..... 17

Turning On & First Time Setup..... 34

### Basic Operation

Playing your AV components ..... 40  
Listening to the Radio ..... 42

Enjoying the Listening Modes ..... 48

Advanced Operation ..... 55

Troubleshooting ..... 65

## WARNING:

TO REDUCE THE RISK OF FIRE OR ELECTRIC SHOCK, DO NOT EXPOSE THIS APPARATUS TO RAIN OR MOISTURE.

## CAUTION:

TO REDUCE THE RISK OF ELECTRIC SHOCK, DO NOT REMOVE COVER (OR BACK). NO USER-SERVICEABLE PARTS INSIDE. REFER SERVICING TO QUALIFIED SERVICE PERSONNEL.



**WARNING**  
RISK OF ELECTRIC SHOCK  
DO NOT OPEN

**AVIS**  
RISQUE DE CHOC ELECTRIQUE  
NE PAS OUVRIR



The lightning flash with arrowhead symbol, within an equilateral triangle, is intended to alert the user to the presence of uninsulated “dangerous voltage” within the product’s enclosure that may be of sufficient magnitude to constitute a risk of electric shock to persons.



The exclamation point within an equilateral triangle is intended to alert the user to the presence of important operating and maintenance (servicing) instructions in the literature accompanying the appliance.

## Important Safety Instructions

1. Read these instructions.
2. Keep these instructions.
3. Heed all warnings.
4. Follow all instructions.
5. Do not use this apparatus near water.
6. Clean only with dry cloth.
7. Do not block any ventilation openings. Install in accordance with the manufacturer’s instructions.
8. Do not install near any heat sources such as radiators, heat registers, stoves, or other apparatus (including amplifiers) that produce heat.
9. Do not defeat the safety purpose of the polarized or grounding-type plug. A polarized plug has two blades with one wider than the other. A grounding type plug has two blades and a third grounding prong. The wide blade or the third prong are provided for your safety. If the provided plug does not fit into your outlet, consult an electrician for replacement of the obsolete outlet.
10. Protect the power cord from being walked on or pinched particularly at plugs, convenience receptacles, and the point where they exit from the apparatus.
11. Only use attachments/accessories specified by the manufacturer.
12. Use only with the cart, stand, tripod, bracket, or table specified by the manufacturer, or sold with the apparatus. When a cart is used, use caution when moving the cart/apparatus combination to avoid injury from tip-over.  
  
PORTABLE CART WARNING  
S3125A
13. Unplug this apparatus during lightning storms or when unused for long periods of time.
14. Refer all servicing to qualified service personnel. Servicing is required when the apparatus has been damaged in any way, such as power-supply cord or plug is damaged, liquid has been spilled or objects have fallen into the apparatus, the apparatus has been exposed to rain or moisture, does not operate normally, or has been dropped.
15. Damage Requiring Service  
Unplug the apparatus from the wall outlet and refer servicing to qualified service personnel under the following conditions:
  - A. When the power-supply cord or plug is damaged,
  - B. If liquid has been spilled, or objects have fallen into the apparatus,
  - C. If the apparatus has been exposed to rain or water,
  - D. If the apparatus does not operate normally by following the operating instructions. Adjust only those controls that are covered by the operating instructions as an improper adjustment of other controls may result in damage and will often require extensive work by a qualified technician to restore the apparatus to its normal operation,
  - E. If the apparatus has been dropped or damaged in any way, and
  - F. When the apparatus exhibits a distinct change in performance this indicates a need for service.
16. Object and Liquid Entry  
Never push objects of any kind into the apparatus through openings as they may touch dangerous voltage points or short-out parts that could result in a fire or electric shock.  
The apparatus shall not be exposed to dripping or splashing and no objects filled with liquids, such as vases shall be placed on the apparatus.  
Don’t put candles or other burning objects on top of this unit.
17. Batteries  
Always consider the environmental issues and follow local regulations when disposing of batteries.
18. If you install the apparatus in a built-in installation, such as a bookcase or rack, ensure that there is adequate ventilation.  
Leave 20 cm (8") of free space at the top and sides and 10 cm (4") at the rear. The rear edge of the shelf or board above the apparatus shall be set 10 cm (4") away from the rear panel or wall, creating a flue-like gap for warm air to escape.

# Precautions

1. **Recording Copyright**—Unless it's for personal use only, recording copyrighted material is illegal without the permission of the copyright holder.
2. **AC Fuse**—The AC fuse inside the unit is not user-serviceable. If you cannot turn on the unit, contact your Onkyo dealer.
3. **Care**—Occasionally you should dust the unit all over with a soft cloth. For stubborn stains, use a soft cloth dampened with a weak solution of mild detergent and water. Dry the unit immediately afterwards with a clean cloth. Don't use abrasive cloths, thinners, alcohol, or other chemical solvents, because they may damage the finish or remove the panel lettering.

## 4. Power WARNING

BEFORE PLUGGING IN THE UNIT FOR THE FIRST TIME, READ THE FOLLOWING SECTION CAREFULLY.

AC outlet voltages vary from country to country. Make sure that the voltage in your area meets the voltage requirements printed on the unit's rear panel (e.g., AC 230–240 V, 50 Hz or AC 120 V, 60 Hz).

The power cord plug is used to disconnect this unit from the AC power source. Make sure that the plug is readily operable (easily accessible) at all times.

Some models have a voltage selector switch for compatibility with power systems around the world. Before you plug in such a model, make sure that the voltage selector is set to the correct voltage for your area. Before you plug in this model, make sure that the voltage selector is set to the correct voltage for your area. If it isn't, use a small screwdriver to set it as appropriate. For example, if the voltage in your area is 120 volts, set the selector to "120V." If it's between 220 and 240 volts, set it to "220-240V."

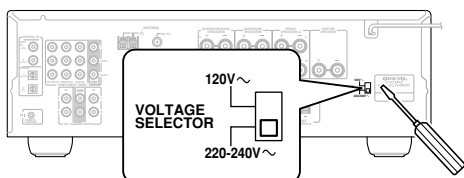

Pressing the [STANDBY/ON] button to select Standby mode does not fully shutdown the unit. If you do not intend to use the unit for an extended period, remove the power cord from the AC outlet.

5. **Never Touch this Unit with Wet Hands**—Never handle this unit or its power cord while your hands are wet or damp. If water or any other liquid gets inside this unit, have it checked by your Onkyo dealer.
6. **Handling Notes**
  - If you need to transport this unit, use the original packaging to pack it how it was when you originally bought it.

- Do not leave rubber or plastic items on this unit for a long time, because they may leave marks on the case.
- This unit's top and rear panels may get warm after prolonged use. This is normal.
- If you do not use this unit for a long time, it may not work properly the next time you turn it on, so be sure to use it occasionally.

## For U.S. models

### FCC Information for User

#### CAUTION:

The user changes or modifications not expressly approved by the party responsible for compliance could void the user's authority to operate the equipment.

#### NOTE:

This equipment has been tested and found to comply with the limits for a Class B digital device, pursuant to Part 15 of the FCC Rules. These limits are designed to provide reasonable protection against harmful interference in a residential installation.

This equipment generates, uses and can radiate radio frequency energy and, if not installed and used in accordance with the instructions, may cause harmful interference to radio communications. However, there is no guarantee that interference will not occur in a particular installation. If this equipment does cause harmful interference to radio or television reception, which can be determined by turning the equipment off and on, the user is encouraged to try to correct the interference by one or more of the following measures:

- Reorient or relocate the receiving antenna.
- Increase the separation between the equipment and receiver.
- Connect the equipment into an outlet on a circuit different from that to which the receiver is connected.
- Consult the dealer or an experienced radio/TV technician for help.

## For Canadian Models

**NOTE:** THIS CLASS B DIGITAL APPARATUS COMPLIES WITH CANADIAN ICES-003.

For models having a power cord with a polarized plug:

**CAUTION:** TO PREVENT ELECTRIC SHOCK, MATCH WIDE BLADE OF PLUG TO WIDE SLOT, FULLY INSERT.

## Modèle pour les Canadien

**REMARQUE:** CET APPAREIL NUMÉRIQUE DE LA CLASSE B EST CONFORME À LA NORME NMB-003 DU CANADA.

Sur les modèles dont la fiche est polarisée:

**ATTENTION:** POUR ÉVITER LES CHOCS ÉLECTRIQUES, INTRODUIRE LA LAME LA PLUS LARGE DE LA FICHE DANS LA BORNE CORRESPONDANTE DE LA PRISE ET POUSSER JUSQU'AU FOND.

## Precautions—Continued

### For British models

Replacement and mounting of an AC plug on the power supply cord of this unit should be performed only by qualified service personnel.

#### IMPORTANT

The wires in the mains lead are coloured in accordance with the following code:

Blue: Neutral

Brown: Live

As the colours of the wires in the mains lead of this apparatus may not correspond with the coloured markings identifying the terminals in your plug, proceed as follows:

The wire which is coloured blue must be connected to the terminal which is marked with the letter N or coloured black.

The wire which is coloured brown must be connected to the terminal which is marked with the letter L or coloured red.

#### IMPORTANT

The plug is fitted with an appropriate fuse. If the fuse needs to be replaced, the replacement fuse must be approved by ASTA or BSI to BS1362 and have the same ampere rating as that indicated on the plug. Check for the ASTA mark or the BSI mark on the body of the fuse. If the power cord's plug is not suitable for your socket outlets, cut it off and fit a suitable plug. Fit a suitable fuse in the plug.

### For European Models

#### Declaration of Conformity

We, ONKYO EUROPE  
ELECTRONICS GmbH  
LIEGNITZERSTRASSE 6,  
82194 GROEBENZELL,  
GERMANY



declare in own responsibility, that the ONKYO product described in this instruction manual is in compliance with the corresponding technical standards such as EN60065, EN55013, EN55020 and EN61000-3-2, -3-3.

GROEBENZELL, GERMANY

K. MIYAGI

ONKYO EUROPE ELECTRONICS GmbH

TX-SR575 incorporates copyright protection technology that is protected by U.S. patents and other intellectual property rights. Use of this copyright protection technology must be authorized by Macrovision Corporation, and is intended for home and other limited consumer uses only unless otherwise authorized by Macrovision. Reverse engineering or disassembly is prohibited.

## Supplied Accessories

Make sure you have the following accessories:

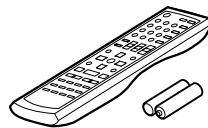

Remote controller and two batteries (AA/R6)



Indoor FM antenna

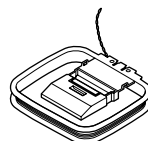

AM loop antenna

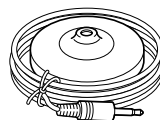

Speaker setup microphone



Speaker terminal tool

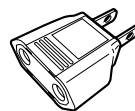

Power-plug adapter

Only supplied in certain countries. Use this adapter if your AC outlet does not match with the plug on the AV receiver's power cord. (Adapter varies from country to country.)

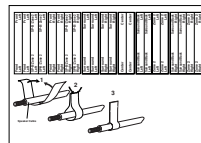

Speaker cable labels

\* In catalogs and on packaging, the letter at the end of the product name indicates the color. Specifications and operation are the same regardless of color.

# Features

## Amplifier

- 7-channel amplifier
- 75 watts per channel rms into 8 ohms, 2 channels driven, 20 Hz to 20 kHz, less than 0.08% total harmonic distortion (FTC rating)
- WRAT (Wide Range Amplifier Technology)
- Optimum Gain Volume Circuitry
- Audyssey 2EQ room correction\*1

## Processing

- Dolby\*2 Digital EX and Dolby Pro Logic IIx
- DTS, DTS-ES Matrix/Discrete, DTS Neo:6, and DTS 96/24\*3
- Theater-Dimensional\*4 virtual surround sound
- Linear PCM 192 kHz/24-bit D/A converters on all channels
- Pure Audio listening mode (not North American model)
- Powerful and highly accurate 32-bit DSP processing

## Audio/Video

- Adjustable crossover (40, 50, 60, 80, 100, 120, 150, 200 Hz)
- HDTV-capable component video (3 inputs, 1 output)
- 3 S-Video inputs, 2 outputs
- 4 assignable digital inputs (2 optical, 2 coaxial)
- Subwoofer pre out
- Color-coded 7.1 multichannel input for use with Super Audio CD and DVD-Audio
- A/B speaker drive
- Color-coded speaker terminal posts

## Tuner

- 40 radio presets
- AM/FM auto tuning
- RDS (Radio Data System) (Europe only)

## Remote Controller

- Preprogrammed for use with other AV components

## TX-SR505 North American model/ TX-SR505E Only

- 2 HDMI\*5 inputs, 1 output

## TX-SR575 Only

- 2 HDMI\*5 inputs, 1 output
- Composite video and S-Video to component video conversion
- Composite video to S-Video and S-Video to composite video conversion
- Neural Surround\*6 (North American models only)
- XM\*7 Satellite Radio (North American models only)  
\*XM Passport System required; sold separately.
- SIRIUS\*8 Satellite Radio (North American models only)



Manufactured under license from Audyssey Laboratories. U.S. and foreign patents pending. Audyssey 2EQ is a trademark of Audyssey Laboratories.



Manufactured under license from Dolby Laboratories. "Dolby", "Pro Logic" and the double-D symbol are registered trademarks of Dolby Laboratories.



"DTS" and "DTS-ES | Neo: 6" are registered trademarks of DTS, Inc. "96/24" is a trademark of DTS, Inc.



Theater-Dimensional is a trademark of Onkyo Corporation.



HDMI, the HDMI logo and High Definition Multimedia Interface are trademarks or registered trademarks of HDMI Licensing, LLC. This unit incorporates HDMI technology.



Neural Surround name and related logos are trademarks owned by Neural Audio Corporation.



XM Ready® is a registered trademark of XM Satellite Radio Inc. All rights reserved.



©2005 SIRIUS Satellite Radio Inc. "SIRIUS," the SIRIUS dog logo, channel names and logos are trademarks of SIRIUS Satellite Radio Inc. Available only in the contiguous United States (excluding Alaska and Hawaii) and Canada.

# Enjoying Home Theater

## Speaker Sets A and B

You can use two sets of speakers with the AV receiver: *speaker set A* and *speaker set B*.

**Speaker set A** should be used in your main listening room for up to 7.1-channel playback.

\*While speaker set B is on, speaker set A is reduced to 5.1-channel playback.

**Speaker set B** can be used in another room and offers 2-channel stereo playback.

\*Only analog input sources are output by speaker set B.

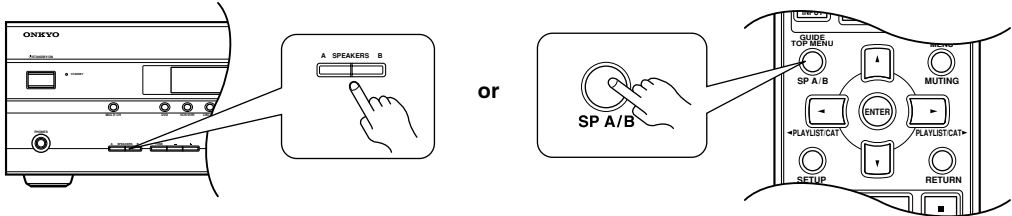

Speaker set A	Speaker set B	Indicator	Output
On	On	<b>A</b> <b>B</b>	Set A: 5.1 channels Set B: 2 channels
	Off	<b>A</b>	Set A: 7.1 channels
Off	On	<b>B</b>	Set B: 2 channels
	Off		No sound

## Main Room (speaker set A)

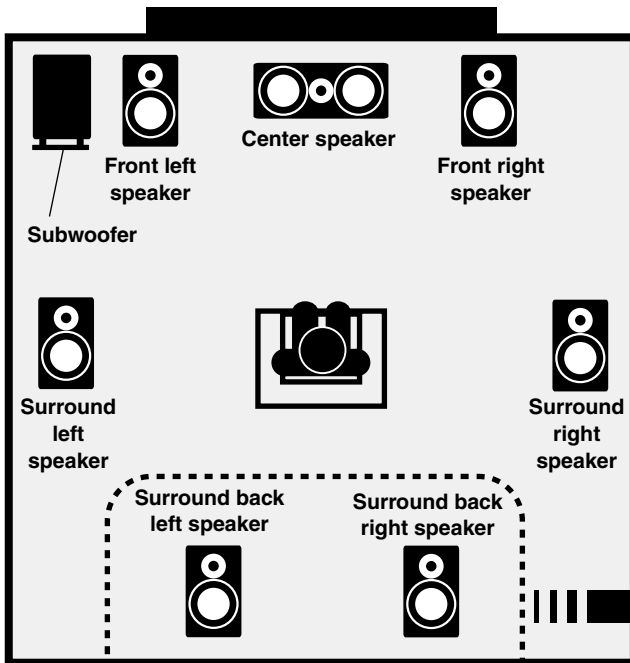

\* While speaker set B is on, the surround back speakers output no sound.

## Sub Room (speaker set B)

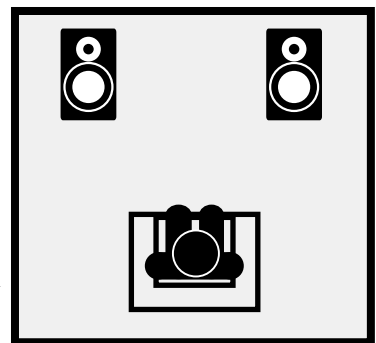

\* Digital input sources are not output by speaker set B. Connect your source component with an analog connection.

# Contents

## Introduction

Important Safety Instructions .....	2
Precautions .....	3
Supplied Accessories.....	4
Features .....	5
<b>Enjoying Home Theater .....</b>	<b>6</b>
Speaker Sets A and B .....	6
<b>Getting to Know the AV Receiver .....</b>	<b>8</b>
<b>Remote Controller.....</b>	<b>12</b>

## Connection

<b>Connecting Your Speakers .....</b>	<b>17</b>
<b>Connecting Antennas.....</b>	<b>20</b>
<b>Connecting Your Components .....</b>	<b>22</b>
About AV Connections .....	22
Connecting Audio and Video Signals to the AV Receiver .....	23
Which Connections Should I Use? .....	23
<b>TV or Projector .....</b>	<b>24</b>
<b>DVD player.....</b>	<b>25</b>
Components with HDMI (TX-SR505 North American Model/ TX-SR505E/TX-SR575 Only) .....	27
VCR or DVD Recorder for Playback .....	28
VCR or DVD Recorder for Recording.....	29
Camcorder, Games Console, or Other Device .....	29
Satellite, Cable, Set-top box, or Other Video Source .....	30
CD Player or Turntable.....	31
RI Dock.....	32
Cassette, CDR, MiniDisc, or DAT Recorder.....	32
<b>Onkyo <b>RI</b> Components .....</b>	<b>33</b>
Connecting the Power Cord .....	33

## Turning On & First Time Setup

<b>Turning On the AV Receiver .....</b>	<b>34</b>
<b>First Time Setup.....</b>	<b>35</b>
Automatic Speaker Setup (Audyssey 2EQ).....	35
Video Input Setup (TX-SR505 North American Model/ TX-SR505E/TX-SR575 Only) .....	38
Digital Audio Input Setup.....	39
Changing the Input Display .....	39

## Basic Operation

<b>Playing Your AV Components .....</b>	<b>40</b>
Basic AV Receiver Operation .....	40
Using the Multichannel DVD Input.....	41
Displaying Source Information.....	41
<b>Listening to the Radio.....</b>	<b>42</b>
Listening to AM/FM Stations.....	42
Presetting AM/FM Stations .....	43
Using RDS (European Models Only) .....	44
<b>Common Functions.....</b>	<b>46</b>
Setting the Display Brightness.....	46
Adjusting the Bass and Treble.....	46
Muting the AV Receiver.....	46
Using the Sleep Timer .....	47
Using Headphones .....	47
Adjusting Speaker Levels .....	47

## Enjoying the Listening Modes

<b>Using the Listening Modes.....</b>	<b>48</b>
Selecting Listening Modes.....	48
About the Listening Modes .....	50
Using the Late Night Function (Dolby Digital only) .....	52
Using the CinemaFILTER.....	52
Using the Audio Adjust Settings .....	52

## Advanced Operation

<b>Recording.....</b>	<b>55</b>
<b>Advanced Setup .....</b>	<b>56</b>
Advanced Speaker Settings .....	56
Digital Input Signal Formats .....	61
Correcting Sound and Picture Sync .....	61
<b>Controlling Other Components.....</b>	<b>62</b>
Entering Remote Control Codes.....	62
Remote Control Codes for Onkyo Components Connected via <b>RI</b> .....	63
Resetting REMOTE MODE Buttons .....	63
Resetting the Remote Controller .....	63

## Troubleshooting .....

**65**  
If you can't resolve an issue, try resetting the AV receiver by holding down the [VCR/DVR] button and pressing the [STANDBY/ON] button.

## Specifications .....

**69**

# Getting to Know the AV Receiver

## Front Panel

### North American Model

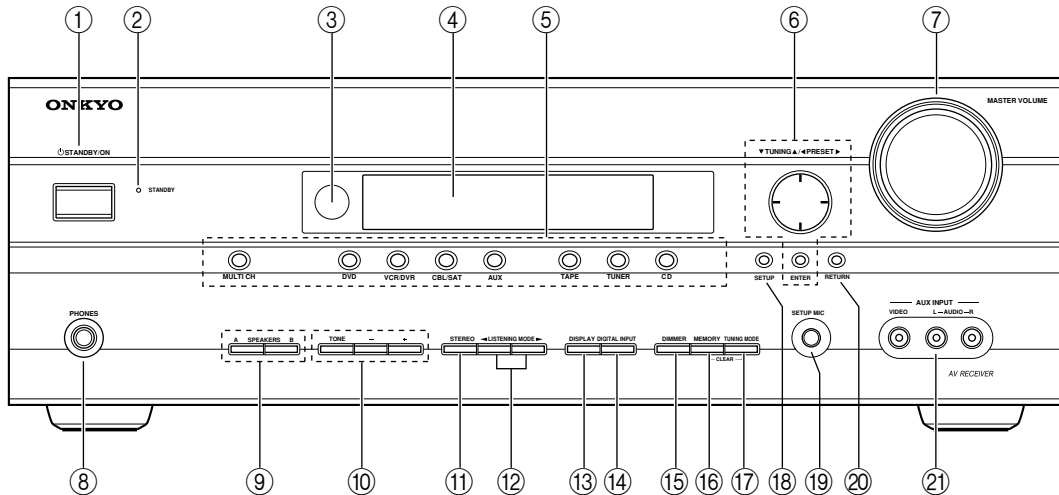

### Other Models

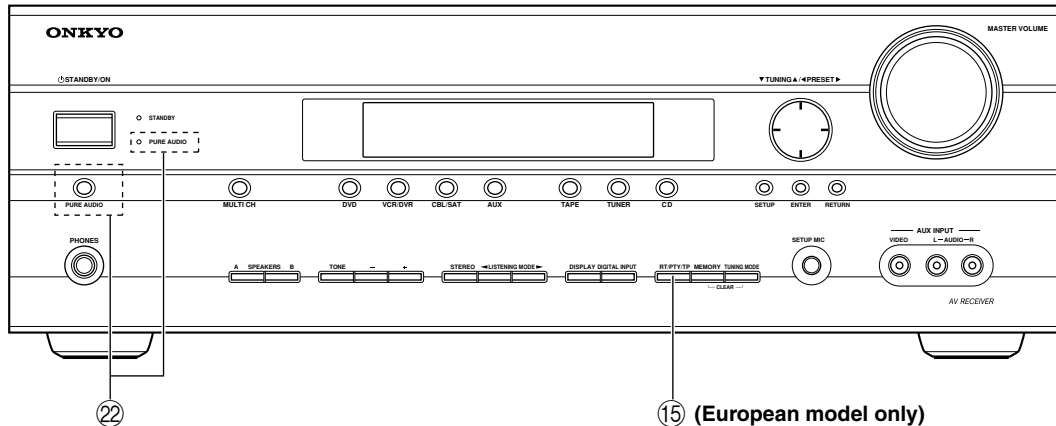

For detailed information, see the pages in parentheses.

- ① **STANDBY/ON button (34)**  
Sets the AV receiver to On or Standby.
- ② **STANDBY indicator (34)**  
Lights up when the AV receiver is on Standby and flashes while a signal is being received from the remote controller.
- ③ **Remote-control sensor (16)**  
Receives control signals from the remote controller.
- ④ **Display**  
See “Display” on page 9.
- ⑤ **Input selector buttons (40)**  
Select the input sources.  
The [MULTI CH] button selects the multichannel DVD input.
- ⑥ **Arrow/TUNING/PRESET and ENTER buttons**  
When the tuner is selected, the TUNING [▲] [▼] buttons are used for radio tuning, and the PRESET [◀] [▶] buttons are used to select radio presets (see page 43). With the setup menus, they work as arrow buttons and are used to select and set items. The ENTER button is also used with the setup menus.
- ⑦ **MASTER VOLUME control (40)**  
Sets the volume of the AV receiver to MIN, 1 through 79, or MAX.
- ⑧ **PHONES jack (47)**  
This 1/4-inch phone jack is for connecting a standard pair of stereo headphones for private listening.
- ⑨ **SPEAKERS A and B buttons (6, 40)**  
Turn speaker sets A and B on or off.



## Getting to Know the AV Receiver—Continued

- ⑩ **TONE, [-], and [+] buttons (46)**  
Used to adjust the bass and treble.
- ⑪ **STEREO button (48)**  
Selects the Stereo listening mode.
- ⑫ **LISTENING MODE [◀]/[▶] buttons (48)**  
Select the listening modes.
- ⑬ **DISPLAY button (41)**  
Displays various information about the currently selected input source.
- ⑭ **DIGITAL INPUT button (39, 61)**  
Used to assign the digital inputs and to specify the format of digital input signals.
- ⑮ **DIMMER or RT/PTY/TP button (45, 46)**  
Adjusts the display brightness.  
On the European model, this is the RT/PTY/TP button, and it's used with RDS (Radio Data System). See "Using RDS (European Models Only)" on page 44.
- ⑯ **MEMORY button (43)**  
Used when storing or deleting radio presets.
- ⑰ **TUNING MODE button (42)**  
Selects the Auto or Manual tuning mode for AM and FM radio.
- ⑱ **SETUP button**  
Used to access the setup menus.
- ⑲ **SETUP MIC (36)**  
The automatic speaker setup microphone connects here.
- ⑳ **RETURN button**  
Selects the previously displayed setup menu.
- ㉑ **AUX INPUT (29, 55)**  
Used to connect a camcorder, games console, and so on. There are jacks for composite video and analog audio.
- ㉒ **PURE AUDIO button and indicator (48)**  
The North American model doesn't have this button and indicator.  
Selects the Pure Audio listening mode. The indicator lights up when this mode is selected.

### Display

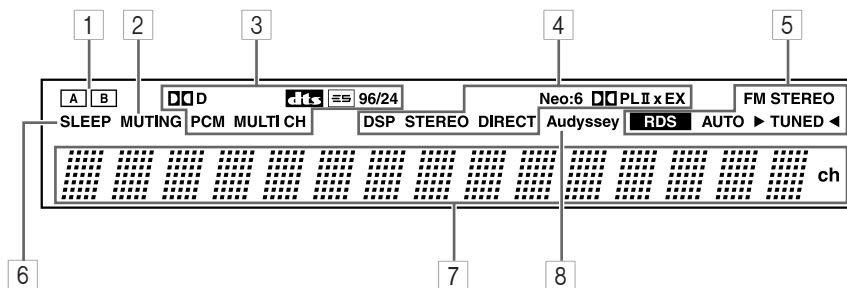

For detailed information, see the pages in parentheses.

- ① **A and B speaker indicators (6, 40)**  
Indicator A lights up when speaker set A is on. Indicator B lights up when speaker set B is on.
- ② **MUTING indicator (46)**  
Flashes while the AV receiver is muted.
- ③ **Input signal format indicators**  
Show the audio signal format of the current input source.
- ④ **Listening mode indicators (50)**  
Show the selected listening mode.
- ⑤ **Radio indicators**  
**FM STEREO (42):** Lights up when tuned to a stereo FM station.
- RDS (European models only) (44):** Lights up when tuned to a radio station that supports RDS (Radio Data System).
- AUTO (42):** For AM and FM radio, lights up when Auto Tuning mode is selected, and disappears when Manual Tuning mode is selected.
- TUNED (42):** Lights up when tuned to a radio station.
- ⑥ **SLEEP indicator (47)**  
Lights up when the Sleep function has been set.
- ⑦ **Message area**  
Displays various information about the selected input source.
- ⑧ **Audyssey indicator (35)**  
Lights up during automatic speaker setup.

# Getting to Know the AV Receiver—Continued

## Rear Panel

### TX-SR505 other than North American model/TX-SR8550

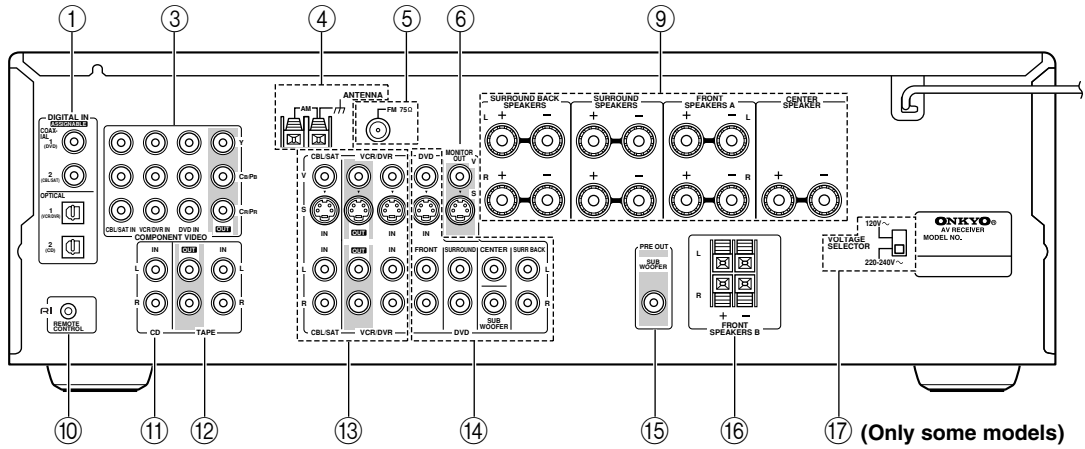

### TX-SR505 North American model/TX-SR505E

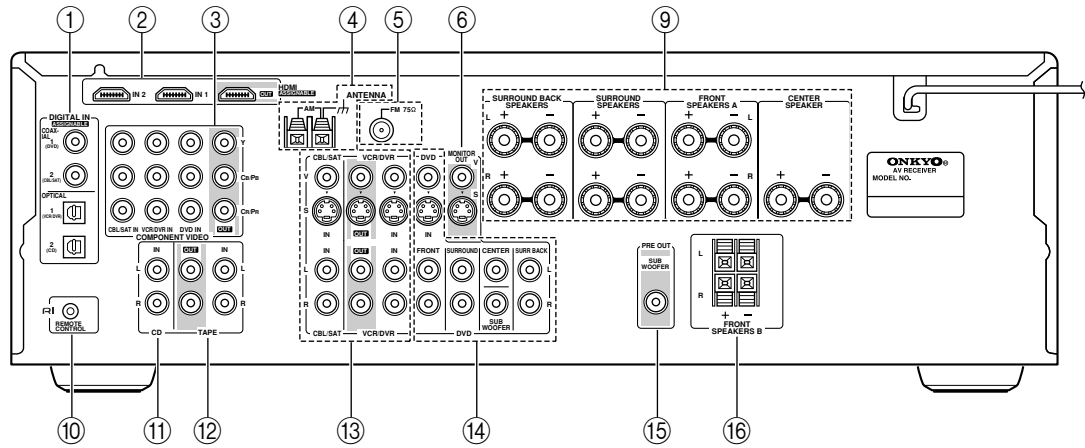

### TX-SR575 (North American model only)

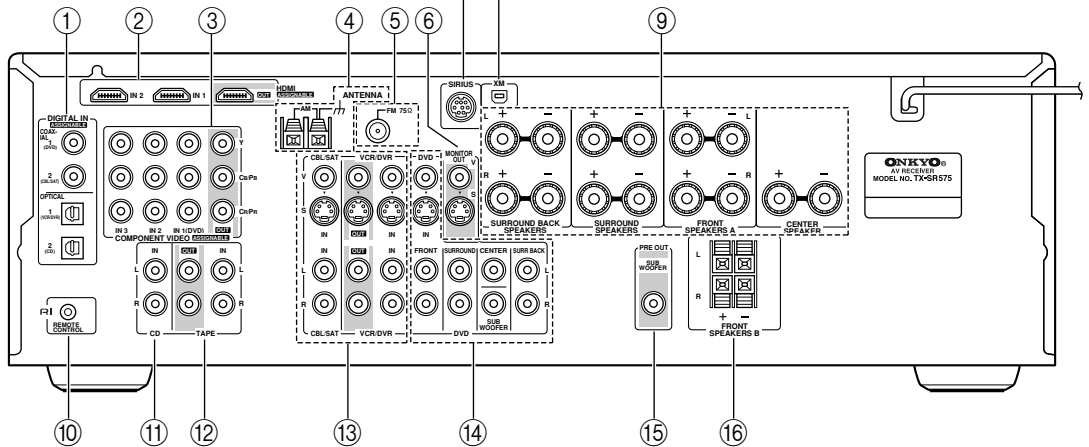

## Getting to Know the AV Receiver—Continued

- ① **DIGITAL IN OPTICAL 1, 2 and COAXIAL 1, 2**  
These optical and coaxial digital audio inputs are for connecting components with optical or coaxial digital audio outputs, such as CD and DVD players.
- ② **HDMI IN 1, 2, and OUT (TX-SR505 North American model/TX-SR505E/TX-SR575 only)**  
These jacks are for connecting HDMI-compatible components. Audio and video signals received by the HDMI IN jacks pass through to the HDMI OUT jack.
- ③ **COMPONENT VIDEO**  
A DVD player, TV, or other component that supports component video can be connected here.
- ④ **AM ANTENNA**  
These push terminals are for connecting an AM antenna.
- ⑤ **FM ANTENNA**  
This jack is for connecting an FM antenna.
- ⑥ **MONITOR OUT**  
The S-Video or composite video output should be connected to a video input on your TV or projector.
- ⑦ **SIRIUS antenna (TX-SR575 North American model only)**  
This jack is for connecting a SIRIUS Satellite Radio antenna (see the separate SIRIUS instructions).
- ⑧ **XM antenna (TX-SR575 North American model only)**  
This jack is for connecting an XM Passport System, sold separately (see the separate XM instructions).
- ⑨ **FRONT SPEAKERS A, SURROUND SPEAKERS, CENTER SPEAKER, and SURROUND BACK SPEAKERS**  
These terminal posts are for connecting speaker set A.
- ⑩ **RI REMOTE CONTROL**  
This **RI** Remote Interactive jack can be connected to the **RI** jack on another **RI**-capable Onkyo component. To use **RI**, you must make an analog audio connection (RCA) between the AV receiver and the other component, even if they are connected digitally.
- ⑪ **CD IN**  
This analog audio input is for connecting a CD player's analog audio output.
- ⑫ **TAPE IN/OUT**  
This analog audio input and output are for connecting a recorder with an analog audio input and output, such as a cassette deck, MD recorder, etc.
- ⑬ **VCR/DVR IN/OUT and CBL/SAT IN**  
The VCR/DVR inputs and outputs can be used to connect a VCR or DVR (digital video recorder). The CBL/SAT inputs can be used to connect a cable/satellite receiver, set-top box, etc.
- ⑭ **DVD IN**  
These jacks can be used to connect a DVD player with an analog multichannel audio output for SACD and DVD-Audio playback.
- ⑮ **SUBWOOFER PRE OUT**  
A powered subwoofer can be connected here.
- ⑯ **FRONT SPEAKERS B**  
These push terminals are for connecting speaker set B.
- ⑰ **VOLTAGE SELECTOR (Only some models)**  
This voltage selector provides compatibility with power systems around the world (see page 3).

See pages 17–33 for hookup information.

# Remote Controller

## Using the Remote Controller

Including the AV receiver, the remote controller can be used to control up to seven different components. The remote controller has a specific operating mode for use with each type of component. Modes are selected by using the six REMOTE MODE buttons.

### RECEIVER/TAPE Mode

In RECEIVER/TAPE mode, you can control the AV receiver and an Onkyo cassette recorder connected via **RI**.

### DVD and CD/MD/CDR/DOCK Modes

With these modes, you can control a DVD player and CD player, MD recorder, CDR, or RI dock. By entering the appropriate remote control code, you can control Onkyo components or components made by other manufacturers (see page 62).

### TV, VCR and SAT/CABLE Modes

With these modes, you can control a TV, VCR, and satellite or cable receiver. You must enter the appropriate remote control code first (see page 62).



**1**

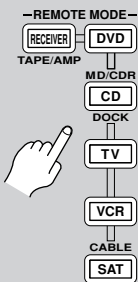

**Press one of the REMOTE MODE buttons to select a mode.**

---

**2**

**Use the buttons supported by that mode to control the component.**

RECEIVER/TAPE mode: see right column

DVD mode: see page 14

CD/MD/CDR/DOCK mode: see page 15

TV, VCR, SAT/CABLE modes: see page 64

## RECEIVER/TAPE Mode

RECEIVER/TAPE mode is used to control the AV receiver. It can also be used to control an Onkyo cassette recorder connected via **RI**.

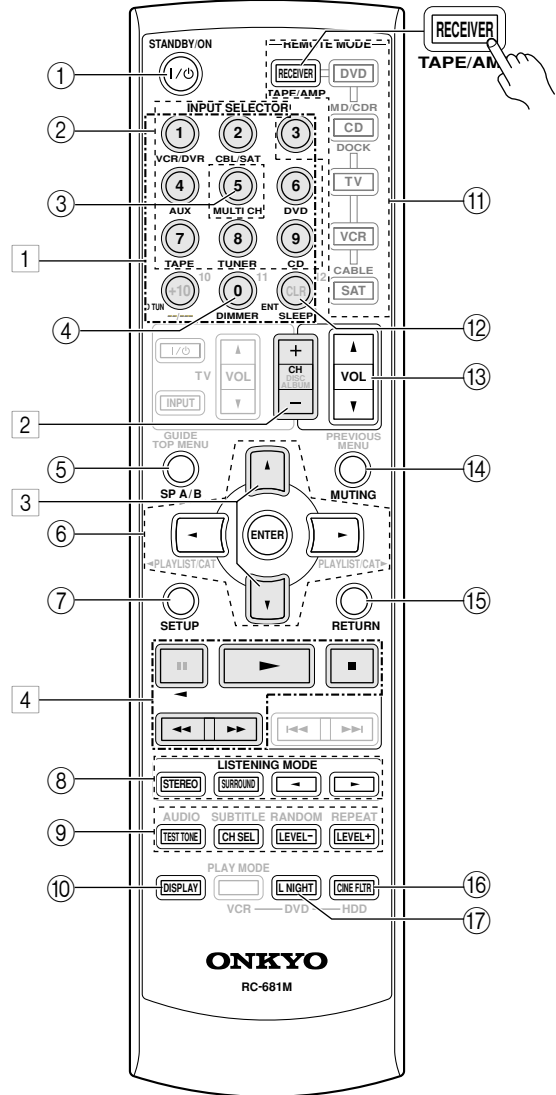

Buttons **1**, **2**, **3**, and **4** are used when the TUNER or TAPE input is selected.

### Note:

Some of the remote controller operations described in this manual may not work as expected with other components.

## Remote Controller—Continued

For detailed information, see the pages in parentheses.

- ① **STANDBY/ON button (34)**  
Sets the AV receiver to On or Standby.
- ② **INPUT SELECTOR buttons (40)**  
Used to select the input sources.
- ③ **MULTI CH button (41)**  
Selects the multichannel DVD input.
- ④ **DIMMER button (46)**  
Adjusts the display brightness.
- ⑤ **SP A/B button (6, 40)**  
Used to turn speaker sets A and B on or off.
- ⑥ **Arrow [▲]/[▼]/[◀]/[▶] and ENTER buttons**  
Used to select and adjust settings.
- ⑦ **SETUP button**  
Used to access the setup menus.
- ⑧ **LISTENING MODE buttons (48)**  
Used to select the listening modes. These buttons work in all remote controller modes.  
**STEREO button**  
Selects the Stereo listening mode.  
**SURROUND button**  
Selects the Dolby and DTS listening modes and the Neural Surround listening mode (TX-SR575 North American model only).  
**[◀]/[▶] buttons**  
Used to select the available listening modes.
- ⑨ **TEST TONE, CH SEL, LEVEL-, and LEVEL+ buttons (47, 59)**  
Used to adjust the level of each speaker.
- ⑩ **DISPLAY button (41)**  
Displays various information about the selected input source.
- ⑪ **REMOTE MODE buttons (12)**  
Used to select the remote controller modes. When a remote controller button is pressed, the REMOTE MODE button for the currently selected mode lights up.
- ⑫ **SLEEP button (47)**  
Used with the Sleep function.
- ⑬ **VOL [▲]/[▼] button (40)**  
Adjusts the volume of the AV receiver regardless of the currently selected remote controller mode.
- ⑭ **MUTING button (46)**  
Mutes or unmutes the AV receiver.
- ⑮ **RETURN button**  
Selects the previously displayed setup menu.
- ⑯ **CINE FLTR button (52)**  
Used with the CinemaFILTER function.
- ⑰ **L NIGHT button (52)**  
Used with the Late Night function.

### ■ Buttons used when the TUNER input is selected

To select the Tuner (AM/FM) as the input source, press:



- ① **Number, D TUN, and ENT buttons (43)**  
Used to select AM and FM radio stations directly.
- ② **CH +/- button (43)**  
Used to select radio presets.
- ③ **Arrow [▲]/[▼] buttons**  
For AM and FM, the Up and Down [▲]/[▼] buttons are used for tuning.

### ■ Buttons used when the TAPE input is selected

To select your Cassette deck as the input source, press:



- ④ **Playback buttons**  
On twin cassette decks, only deck B can be controlled.  
**Play [▶] button**  
Starts playback.  
**Stop [■] button**  
Stops playback.  
**Reverse Play [◀] button**  
Starts reverse playback.  
**Rewind and FF [◀◀]/[▶▶] buttons**  
The Rewind [◀◀] button starts rewind. The FF [▶▶] button starts fast forward.

## DVD Mode

By default, the remote controller is set to control an Onkyo DVD player.

To select your DVD player as the input source, press:

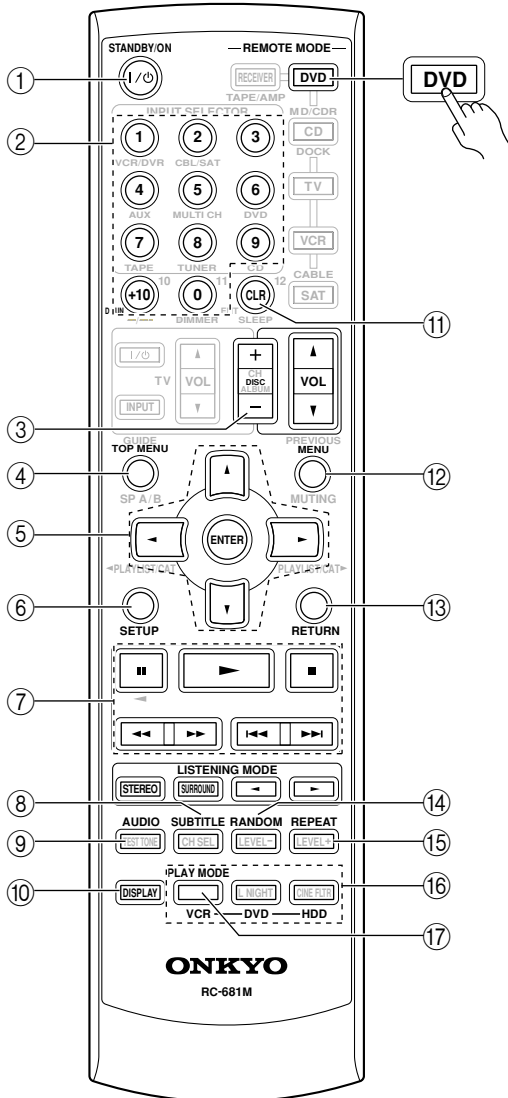

- ① **STANDBY/ON button**  
Sets the DVD player to On or Standby.
- ② **Number buttons**  
Used to enter title, chapter, and track numbers and times for locating specific points.
- ③ **DISC +/- button**  
Selects discs on a DVD changer.
- ④ **TOP MENU button**  
Selects a DVD's top menu.
- ⑤ **Arrow [▲]/[▼]/[◀]/[▶] and ENTER buttons**  
Used to navigate DVD menus and the DVD player's onscreen setup menus.
- ⑥ **SETUP button**  
Used to access the DVD player's onscreen setup menus.
- ⑦ **Playback buttons**  
From left to right: Pause, Play, Stop, Fast Reverse, Fast Forward, Previous, and Next.
- ⑧ **SUBTITLE button**  
Selects subtitles.
- ⑨ **AUDIO button**  
Selects foreign language soundtracks and audio formats (e.g., Dolby Digital or DTS).
- ⑩ **DISPLAY button**  
Displays information about the current disc, title, chapter, or track, including elapsed time, remaining time, total time, and so on.
- ⑪ **CLR button**  
Cancels functions and clears entered numbers.
- ⑫ **MENU button**  
Displays a DVD's menu.
- ⑬ **RETURN button**  
Exits the DVD player's onscreen setup menus.
- ⑭ **RANDOM button**  
Used with the random playback function.
- ⑮ **REPEAT button**  
Used with the repeat playback functions.
- ⑯ **VCR, DVD, and HDD buttons**  
Used to select VCR, HDD (hard disk drive), or DVD playback on a VCR/DVD recorder with a built-in hard disk drive.
- ⑰ **PLAY MODE button**  
Selects play modes on components with selectable play modes.

## CD/MD/CDR/DOCK Mode

By default, the remote controller is set to control an Onkyo CD player.

To select the input source, press:

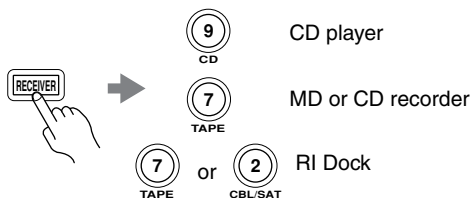

\* If you're using an MD, CDR, or an RI Dock, you must change the Input Display (see page 39).

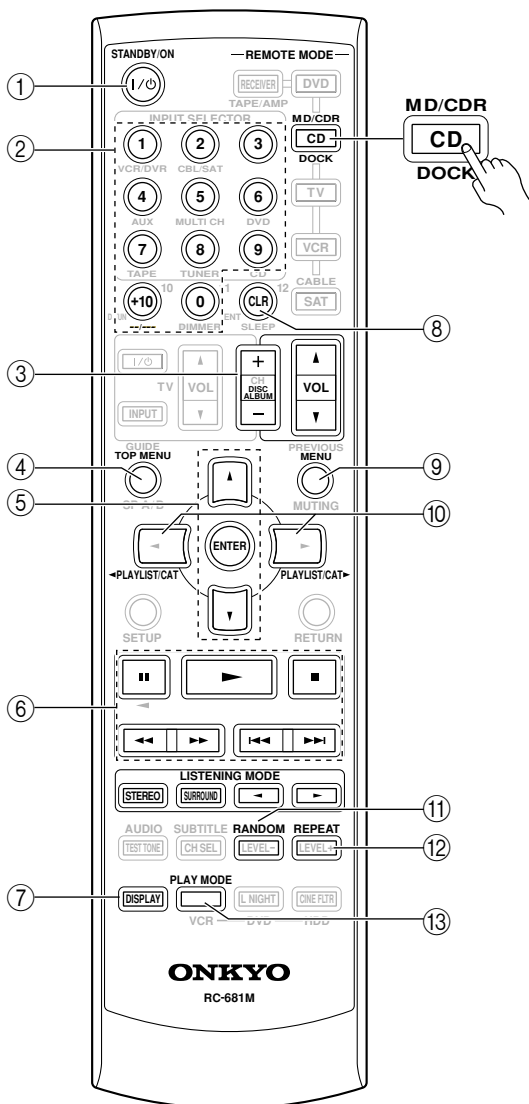

- ① **STANDBY/ON button**  
Sets the component to On or Standby.
- ② **Number buttons**  
Used to enter track numbers and times for locating specific points on CD/MD players.
- ③ **DISC/ALBUM +/- button**  
Selects discs on a CD changer, or the next or previous album on an HDD-compatible component connected to an RI Dock.
- ④ **TOP MENU button**  
Works as a Mode button when used with a DS-A2 RI Dock.
- ⑤ **Arrow [▲]/[▼] and ENTER buttons**  
Used to navigate menus on an HDD-compatible component connected to an RI Dock.
- ⑥ **Playback buttons**  
From left to right: Pause, Play, Stop, Fast Reverse, Fast Forward, Previous and Next.
- ⑦ **DISPLAY button**  
Displays information about the current disc or track on a CD player or MD/CD recorder, including elapsed time, remaining time, total time, and so on. On an HDD-compatible component connected to an RI Dock, it turns on the back light for 30 seconds.
- ⑧ **CLR button**  
Cancels functions and clears entered numbers on a CD player or MD/CD recorder.
- ⑨ **MENU button**  
Used to navigate menus on an HDD-compatible component connected to an RI Dock.
- ⑩ **PLAYLIST [◀]/[▶] buttons**  
Selects the previous or next playlist on an HDD-compatible component connected to an RI Dock.
- ⑪ **RANDOM button**  
Used with the random/shuffle playback function.
- ⑫ **REPEAT button**  
Used with the repeat playback functions.
- ⑬ **PLAY MODE button**  
Used to select play modes on components with selectable play modes. Works as a Resume button when used with a DS-A2 RI Dock.

### Installing the Batteries

- 1 To open the battery compartment, press the small hollow and slide open the cover.**

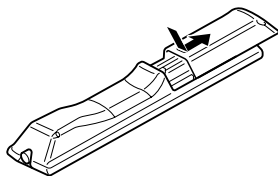

- 2 Insert the two supplied batteries (AA/R6) in accordance with the polarity diagram inside the battery compartment.**

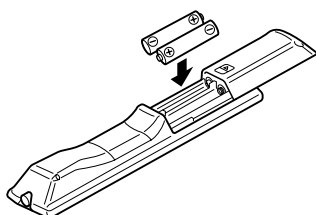

- 3 Slide the cover shut.**

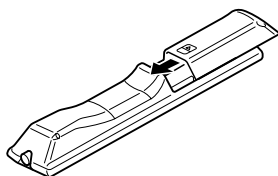

#### Notes:

- If the remote controller doesn't work reliably, try replacing the batteries.
- Don't mix new and old batteries or different types of batteries.
- If you intend not to use the remote controller for a long time, remove the batteries to prevent damage from leakage or corrosion.
- Expired batteries should be removed as soon as possible to prevent damage from leakage or corrosion.

### Aiming the Remote Controller

When using the remote controller, point it toward the AV receiver's remote control sensor, as shown below.

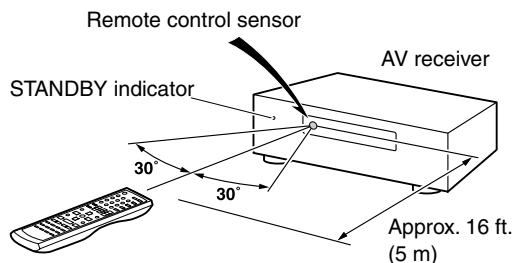

#### Notes:

- The remote controller may not work reliably if the AV receiver is subjected to bright light, such as direct sunlight or inverter-type fluorescent lights. Keep this in mind when installing.
- If another remote controller of the same type is used in the same room, or the AV receiver is installed close to equipment that uses infrared rays, the remote controller may not work reliably.
- Don't put anything on top of the remote controller, such as a book or magazine, because a button may be pressed continuously, thereby draining the batteries.
- The remote controller may not work reliably if the AV receiver is installed in a rack behind colored glass doors. Keep this in mind when installing.
- The remote controller will not work if there's an obstacle between it and the AV receiver's remote control sensor.



# Connecting Your Speakers

## Enjoying Home Theater

Thanks to the AV receiver's superb capabilities, you can enjoy surround sound with a real sense of movement in your own home—just like being in a movie theater or concert hall. You can enjoy DVDs featuring DTS and Dolby Digital. With analog and digital TV, you can enjoy Dolby Pro Logic IIx and Onkyo's own DSP surround listening modes.

### Front left and right speakers

These output the overall sound. Their role in a home theater is to provide a solid anchor for the sound image. They should be positioned facing the listener at about ear level, and equally spaced from the TV. Angle them inward slightly so as to create a triangle, with the listener at the apex.

### Center speaker

This speaker enhances the front left and right speakers, making sound movements distinct and providing a full sound image. For movies it's used mainly for dialog.

Position it close to your TV facing forward at about ear level, or at the same height as the front left and right speakers.

### Subwoofer

The subwoofer handles the bass sounds of the LFE (Low-Frequency Effects) channel. The volume and quality of the bass output from your subwoofer will depend on its position, the shape of your listening room, and your listening position. In general, a good bass sound can be obtained by installing the subwoofer in a front corner, or at one-third the way along the wall, as shown.

**Tip:** To find the best position for your subwoofer, while playing a movie or some music with good bass, experiment by placing your subwoofer at various positions within the room, and choose the one that provides the most satisfying results.

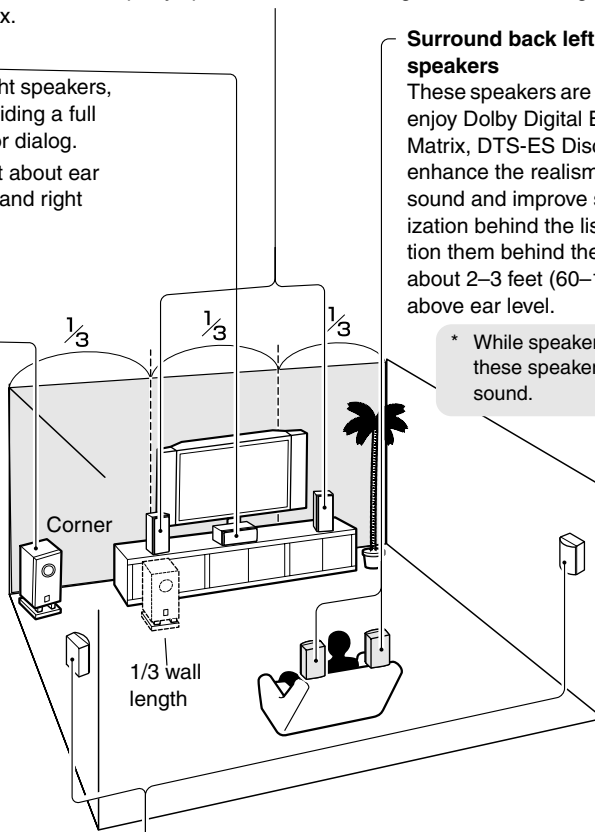

### Surround back left and right speakers

These speakers are necessary to enjoy Dolby Digital EX, DTS-ES Matrix, DTS-ES Discrete. They enhance the realism of surround sound and improve sound localization behind the listener. Position them behind the listener about 2–3 feet (60–100 cm) above ear level.

\* While speaker set B is on, these speakers output no sound.

### Surround left and right speakers

These speakers are used for precise sound positioning and to add realistic ambience. Position them at the sides of the listener, or slightly behind, about 2–3 feet (60–100 cm) above ear level. Ideally they should be equally spaced from the listener.

## Speaker Configuration

For the best surround-sound experience, you should connect seven speakers and a powered subwoofer.

The following table shows which channels you should use based on the number of speakers that you have.

Number of speakers:	2	3	4	5	6	7
Front left	✓	✓	✓	✓	✓	✓
Front right	✓	✓	✓	✓	✓	✓
Center		✓		✓	✓	✓
Surround left			✓	✓	✓	✓
Surround right			✓	✓	✓	✓
Surround back*					✓	
Surround back left						✓
Surround back right						✓

\* If you're using only one surround back speaker, connect it to the left (L) SURROUND BACK SPEAKERS terminals.

No matter how many speakers you use, a powered subwoofer is recommended for a really powerful and solid bass.

Before using the AV receiver, you must do the automatic speaker setup (see page 35).

## Speaker Connection Precautions

Read the following before connecting your speakers:

- **North American models:** You can connect speakers with an impedance of between 6 and 16 ohms. If you use speakers with a lower impedance, and use the amplifier at high volume levels for a long period of time, the built-in amp protection circuit may be activated.
- **Other models:** You can connect speakers with an impedance of between 4 and 16 ohms. If the impedance of any of the connected speakers is 4 ohms or more, but less than 6 ohms, be sure to set the minimum speaker impedance to “4 ohms” (see page 35). If you use speakers with a lower impedance, and use the amplifier at high volume levels for a long period of time, the built-in amp protection circuit may be activated.
- Disconnect the power cord from the wall outlet before making any connections.
- Read the instructions supplied with your speakers.
- Pay close attention to speaker wiring polarity. In other words, connect positive (+) terminals to only positive (+) terminals, and negative (–) terminals to only negative (–) terminals. If you get them the wrong way around, the sound will be out of phase and will sound unnatural.
- Unnecessarily long or very thin speaker cables may affect the sound quality and should be avoided.
- Be careful not to short the positive and negative wires. Doing so may damage the AV receiver.
- Don't connect more than one cable to each speaker terminal. Doing so may damage the AV receiver.
- Don't connect a speaker to several terminals.

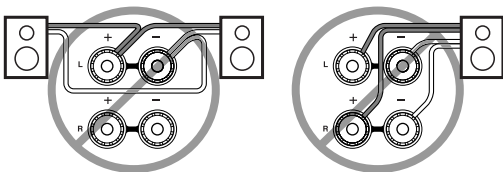
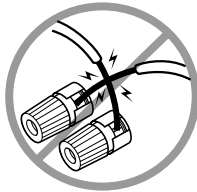

## Attaching the Speaker Labels

The AV receiver's positive (+) speaker terminals are color-coded for ease of identification. (The negative (–) speaker terminals are all black.)

Speaker terminal	Color
Front left	White
Front right	Red
Center	Green
Surround left	Blue
Surround right	Gray
Surround back left	Brown
Surround back right	Tan

The supplied speaker labels are also color-coded and you should attach them to the positive (+) side of each speaker cable in accordance with the above table. All you need to do then is to match the color of each label to the corresponding speaker terminal.



## Using the Speaker Terminal Tool

The supplied speaker terminal tool makes it easy to tighten and loosen the speaker terminals. If you are using banana plugs, to ensure optimum sound quality, tighten the speaker terminal before inserting the banana plug. (In Europe, using banana plugs to connect speakers to an audio amplifier is prohibited.)

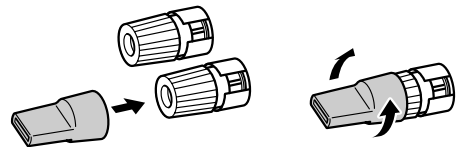

# Connecting Your Speakers—Continued

## Connecting Speaker Set A

**1** Strip 5/8" (15 mm) of insulation from the ends of the speaker cables, and twist the bare wires tightly, as shown.

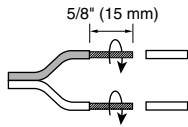

**2** Unscrew the terminal. Fully insert the bare wire, making sure that it's touching the threaded shaft in the center. Screw the terminal tight.



## Connecting Speaker Set B

**1** Strip 3/8" (10 mm) of insulation from the ends of the speaker cables, and twist the bare wires tightly, as shown.

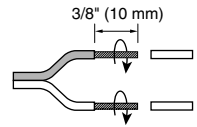

**2** While pressing the lever, insert the wire into the hole, and then release the lever. Make sure that the terminals are gripping the bare wires, not the insulation.

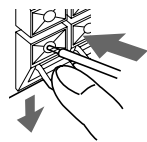

**Note:**

While speaker set B is on, speaker set A is reduced to 5.1-channel playback.

## Connecting a Powered Subwoofer

Using a suitable cable, connect the AV receiver's SUBWOOFER PRE OUT to the input on your powered subwoofer. If your subwoofer is unpowered and you're using an external amplifier, connect the SUBWOOFER PRE OUT to its input.

**Note:**

Make sure the plugs are pushed in all the way.

The following illustration shows which speaker should be connected to each pair of terminals.

If you're using only one surround back speaker, connect it to the left (L) SURROUND BACK SPEAKERS terminals.

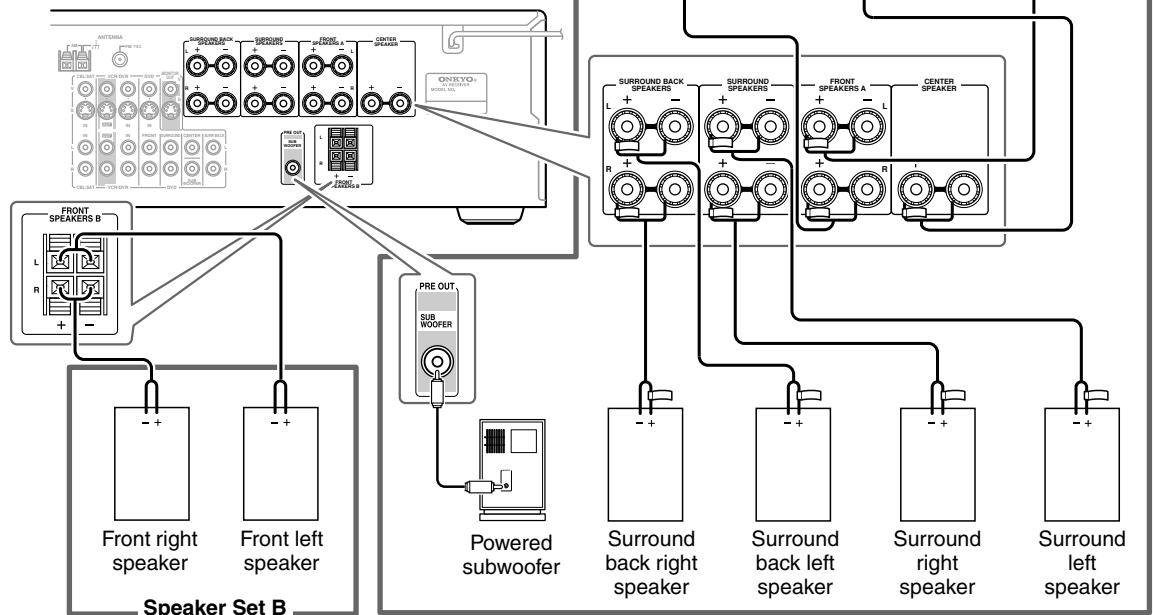

# Connecting Antennas

This section explains how to connect the supplied indoor FM antenna and AM loop antenna, and how to connect commercially available outdoor FM and AM antennas. The AV receiver won't pick up any radio signals without any antenna connected, so you must connect the antenna to use the tuner.

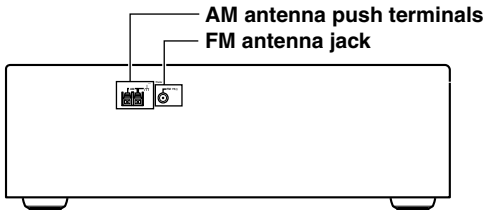

## Connecting the Indoor FM Antenna

The supplied indoor FM antenna is for indoor use only.

### 1 Attach the FM antenna, as shown.

#### ■ American Model

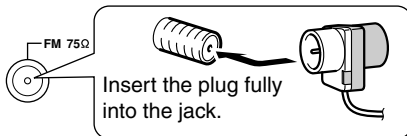

#### ■ Other Models

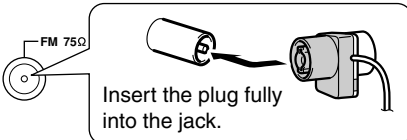

Once your AV receiver is ready for use, you'll need to tune into an FM radio station and adjust the position of the FM antenna to achieve the best possible reception.

### 2 Use thumbtacks or something similar to fix the FM antenna into position.

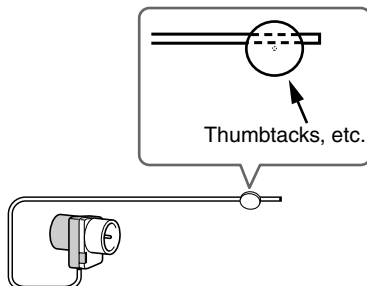

**Caution:** Be careful that you don't injure yourself when using thumbtacks.

If you cannot achieve good reception with the supplied indoor FM antenna, try a commercially available outdoor FM antenna instead (see page 21).

## Connecting the AM Loop Antenna

The supplied indoor AM loop antenna is for indoor use only.

### 1 Assemble the AM loop antenna, inserting the tabs into the base, as shown.

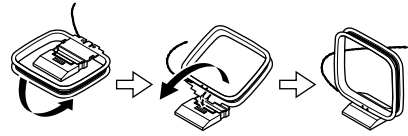

### 2 Connect both wires of the AM loop antenna to the AM push terminals, as shown.

(The antenna's wires are not polarity sensitive, so they can be connected either way around).

Make sure that the wires are attached securely and that the push terminals are gripping the bare wires, not the insulation.

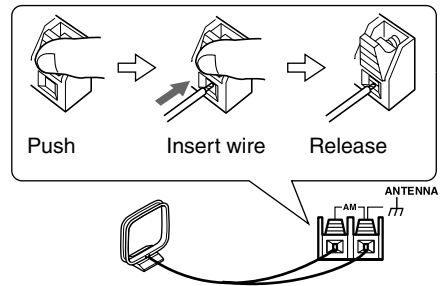

Once your AV receiver is ready for use, you'll need to tune into an AM radio station and adjust the position of the AM antenna to achieve the best possible reception.

Keep the antenna as far away as possible from your AV receiver, TV, speaker cables, and power cords.

If you cannot achieve good reception with the supplied indoor AM loop antenna, try using it with a commercially available outdoor AM antenna (see page 21).

### Connecting an Outdoor FM Antenna

If you cannot achieve good reception with the supplied indoor FM antenna, try a commercially available outdoor FM antenna instead.

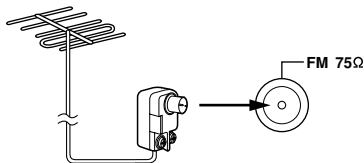

#### Notes:

- Outdoor FM antennas work best outside, but usable results can sometimes be obtained when installed in an attic or loft.
- For best results, install the outdoor FM antenna well away from tall buildings, preferably with a clear line of sight to your local FM transmitter.
- Outdoor antenna should be located away from possible noise sources, such as neon signs, busy roads, etc.
- For safety reasons, outdoor antenna should be situated well away from power lines and other high-voltage equipment.
- Outdoor antenna must be grounded in accordance with local regulations to prevent electrical shock hazards.

#### ■ Using a TV/FM Antenna Splitter

It's best not to use the same antenna for both FM and TV reception, as this can cause interference problems. If circumstances demand it, use a TV/FM antenna splitter, as shown.

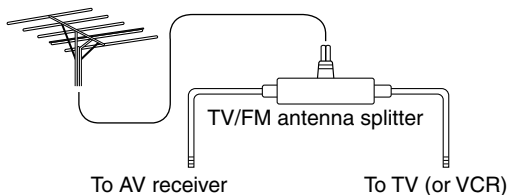

### Connecting an Outdoor AM Antenna

If good reception cannot be achieved using the supplied AM loop antenna, an outdoor AM antenna can be used in addition to the loop antenna, as shown.

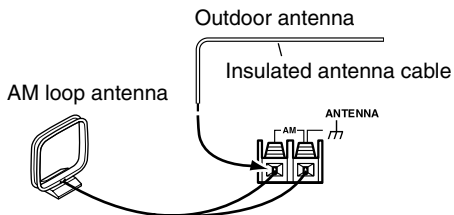

Outdoor AM antennas work best when installed horizontally outside, but good results can sometimes be obtained indoors by mounting horizontally above a window. Note that the AM loop antenna should be left connected. Outdoor antenna must be grounded in accordance with local regulations to prevent electrical shock hazards.

# Connecting Your Components

## About AV Connections

- Before making any AV connections, read the manuals supplied with your other AV components.
- Don't connect the power cord until you've completed and double-checked all AV connections.

## Optical Digital Jacks

The AV receiver's optical digital jacks have shutter-type covers that open when an optical plug is inserted and close when it's removed. Push plugs in all the way.

**Caution:** To prevent shutter damage, hold the optical plug straight when inserting and removing.

## AV Connection Color Coding

RCA-type AV connections are usually color coded: red, white, and yellow. Use red plugs to connect right-channel audio inputs and outputs (typically labeled "R"). Use white plugs to connect left-channel audio inputs and outputs (typically labeled "L"). And use yellow plugs to connect composite video inputs and outputs.

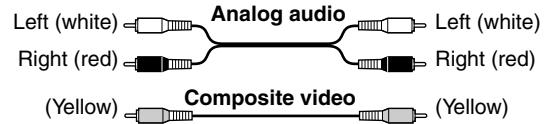

- Push plugs in all the way to make good connections (loose connections can cause noise or malfunctions).
- To prevent interference, keep audio and video cables away from power cords and speaker cables.

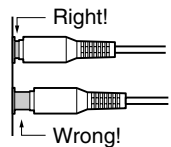

## AV Cables and Jacks

### Video

Cable	Jack	Description
<p>Component video cable</p>		Component video separates the luminance (Y) and color difference signals (Pr, Pb), providing the best picture quality. (Some TV manufacturers label their component video jacks slightly differently.)
<p>S-Video cable</p>		S-Video separates the luminance and color signals and provides better picture quality than composite video.
<p>Composite video cable</p>		Composite video is commonly used on TVs, VCRs, and other video equipment. Use only dedicated composite video cables.

### Audio

Cable	Jack	Description
<p>Optical digital audio cable</p>		This offers the best sound quality and allows you to enjoy Dolby Digital and DTS. The audio quality is the same as for coaxial.
<p>Coaxial digital audio cable</p>		This offers the best sound quality and allows you to enjoy Dolby Digital and DTS. The audio quality is the same as for optical.
<p>Analog audio cable (RCA)</p>		This cable carries analog audio. It's the most common connection format for analog audio and can be found on virtually all AV components.
<p>Multichannel analog audio cable (RCA)</p>		This cable carries multichannel analog audio and is typically used to connect DVD players with a 7.1-channel analog audio output. Several standard analog audio cables can be used instead of a multichannel cable.

**Note:** The AV receiver does not support SCART connections.

## Connecting Audio and Video Signals to the AV Receiver

By connecting both the audio and video outputs of your DVD player and other AV components to the AV receiver, you can switch the audio and video signals simultaneously simply by changing the input source on the AV receiver.

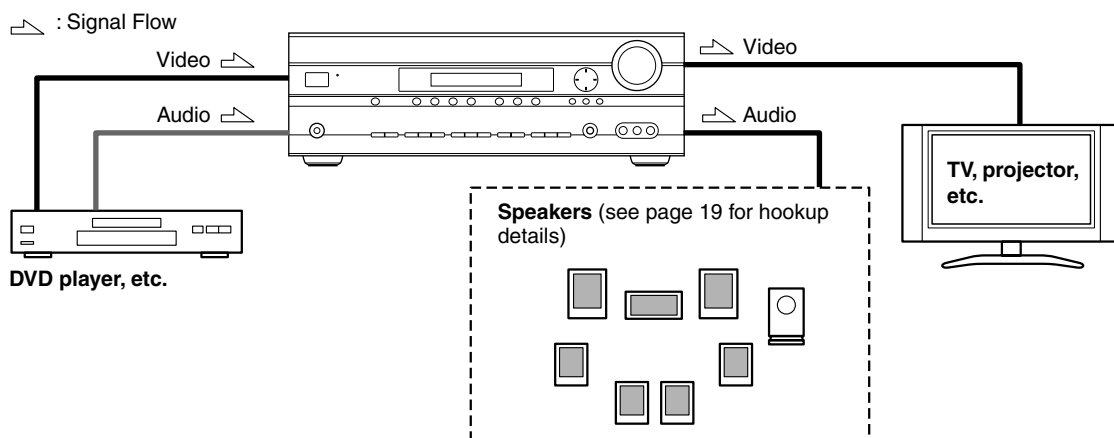

## Which Connections Should I Use?

The AV receiver supports several connection formats for compatibility with a wide range of AV equipment. The format you choose will depend on the formats supported by your other components. Use the following sections as a guide. For video components, such as a DVD player, you must make an audio connection and a video connection.

### Audio Connection Formats

When choosing a connection format, bear in mind that the AV receiver doesn't convert between formats.

### Video Connection Formats

#### For TX-SR505/TX-SR505E/TX-SR8550

Video equipment can be connected by using any one of the following video connection formats: composite video, S-Video, or component video, the latter offering the best picture quality.

When choosing a connection format, bear in mind that the AV receiver doesn't convert between formats, so only outputs of the same format as the input will output the signal.

#### For TX-SR575

Video equipment can be connected to the AV receiver by using any one of the following video connection formats: composite video, S-Video, or component video, the latter offering the best picture quality.

Composite video to S-Video and S-Video to composite video conversion only applies to the MONITOR OUT V and S outputs, not the VCR/DVR OUT V and S outputs.

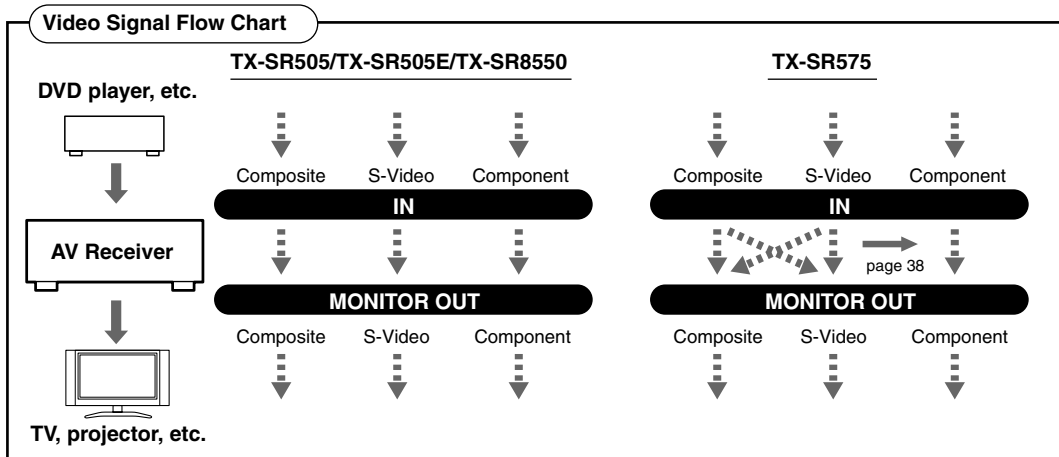

## Connecting Your Components—Continued

### Connecting a TV or Projector

**Step 1: Choose a video connection from **A**, **B**, and **C**.**

**Step 2: Choose an audio connection from **a**, **b**, and **c**.**

- With connection **a**, you can listen to and record audio from your TV and listen via speaker set B.
- To enjoy Dolby Digital and DTS, use connection **b** or **c**. (For recording, use **a** and **b**, or **a** and **c**.)

Connection	AV receiver	Signal flow	TV	Picture quality
<b>A</b>	COMPONENT VIDEO OUT	⇒	Component video input	Best
<b>B</b>	MONITOR OUT S	⇒	S-Video input	Better
<b>C</b>	MONITOR OUT V	⇒	Composite video input	Standard
<b>a</b>	CBL/SAT IN L/R	⇐	Analog audio L/R output	
<b>b</b>	DIGITAL IN COAXIAL 2	⇐	Digital coaxial output	
<b>c</b>	DIGITAL IN OPTICAL 1	⇐	Digital optical output	

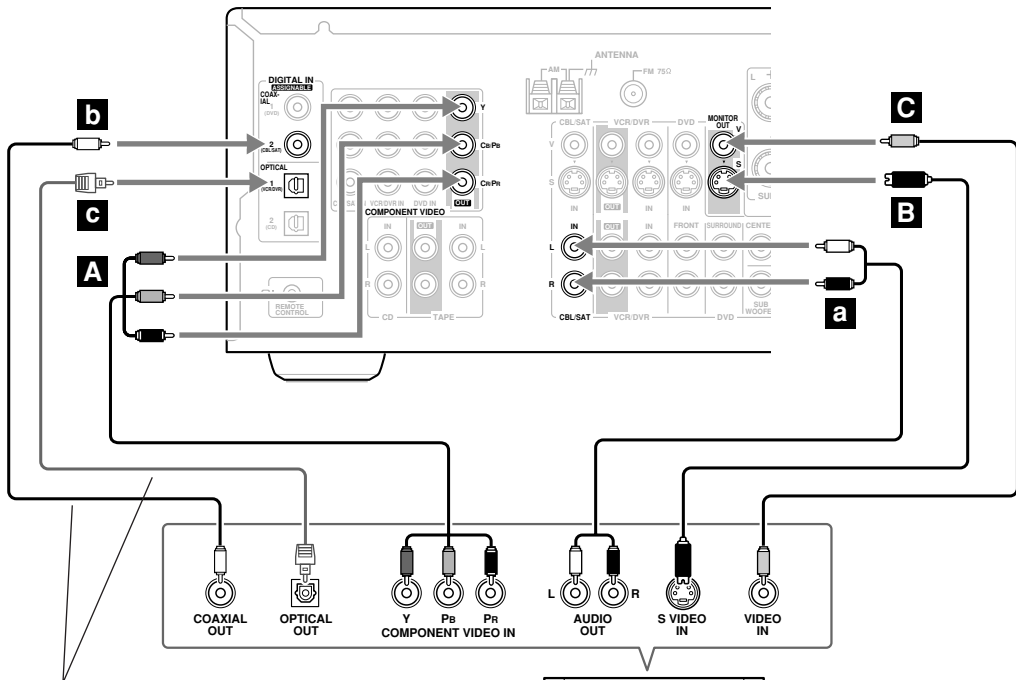

Connect one or the other  
Connection **c** must be assigned (see page 39)



If your TV has no audio outputs, connect an audio output from your VCR or cable or satellite receiver to the AV receiver and use its tuner to listen to TV programs through the AV receiver (see pages 28 and 30).



## Connecting Your Components—Continued

### Connecting a DVD player

#### Step 1: Choose a video connection from **A**, **B**, and **C**.

**TX-SR505/TX-SR505E/TX-SR8550:** You must connect the AV receiver to your TV via the same type of connection.

#### Step 2: Choose an audio connection from **a**, **b**, and **c**.

- With connection **a**, you can listen to and record audio from a DVD and listen via speaker set B.
- To enjoy Dolby Digital and DTS, use connection **b** or **c**. (For recording, use **a** and **b**, or **a** and **c**.)
- If your DVD player has main left and right outputs and multichannel left and right outputs, be sure to use the main left and right outputs for connection **a**.

Connection	AV receiver	Signal flow	DVD player	Picture quality
<b>A</b>	COMPONENT VIDEO DVD IN (TX-SR505/TX-SR505E/TX-SR8550) or COMPONENT VIDEO IN 1 (TX-SR575)	←	Component video output	Best
<b>B</b>	DVD IN S	←	S-Video output	Better
<b>C</b>	DVD IN V	←	Composite video output	Standard
<b>a</b>	DVD IN FRONT	←	Analog audio L/R output	
<b>b</b>	DIGITAL IN COAXIAL 1	←	Digital coaxial output	
<b>c</b>	DIGITAL IN OPTICAL 1	←	Digital optical output	

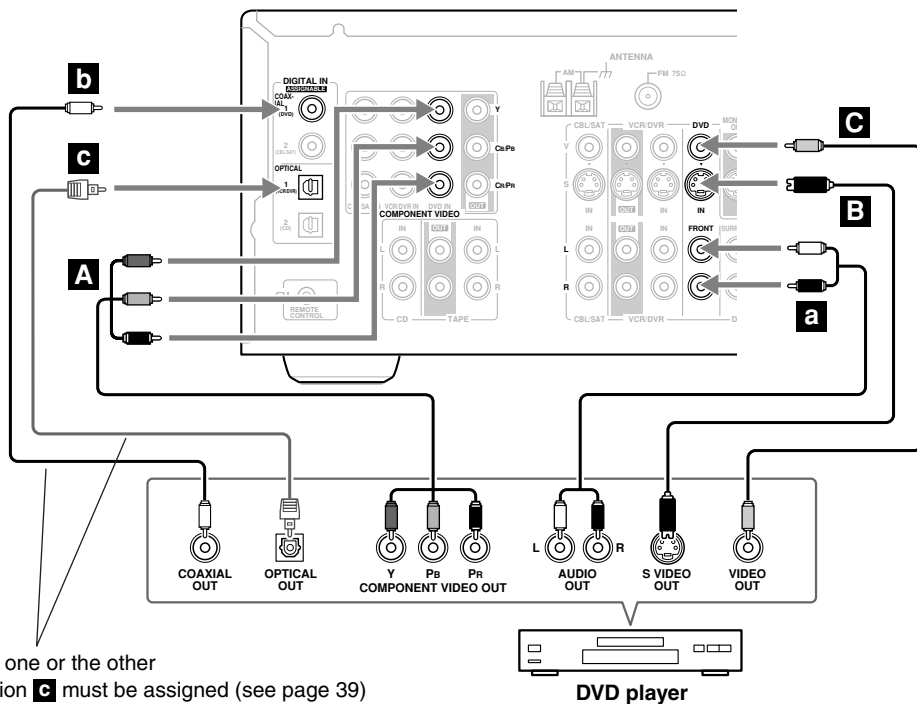

Connect one or the other  
Connection **c** must be assigned (see page 39)

To connect a DVD player or DVD-Audio/SACD-capable player with a multichannel analog audio output, see page 26. ➔

### Hooking Up the Multichannel DVD Input

If your DVD player supports multichannel audio formats such as DVD-Audio or SACD, and it has a multichannel analog audio output, you can connect it to the AV receiver's multichannel DVD input.

Use a multichannel analog audio cable, or several normal audio cables, to connect the AV receiver's DVD IN FRONT L/R, CENTER, SURROUND L/R, SURR BACK L/R, and SUBWOOFER jacks to the 7.1-channel analog audio output on your DVD player. If your DVD player has a 5.1-channel analog audio output, don't connect anything to the AV receiver's SURR BACK L/R jacks.

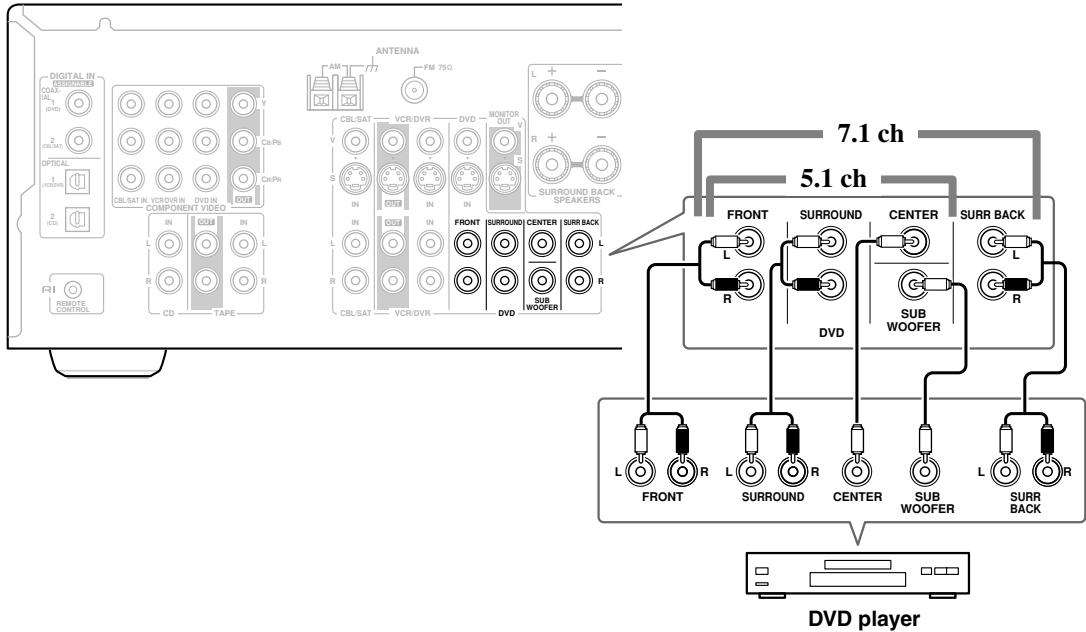

### TX-SR505 North American Model/TX-SR505E/TX-SR575 Only

#### Connecting Components with HDMI

If you have an HDMI-compatible player, you can connect it to the AV receiver with an HDMI cable.

**Step 1: Connect your HDMI-compatible TV to the AV receiver's HDMI OUT jack.**

**Step 2: Connect your HDMI-compatible player to the AV receiver's HDMI IN 1 or 2 jack.**

**Step 3: Connect your HDMI-compatible player to an analog and/or digital audio input on the AV receiver.**

\* Audio and video signals received via the HDMI IN 1 and 2 jacks are output by the HDMI OUT jack as they are (HDMI pass-through), so even if you only make the connections in steps 1 and 2, your TV will output sound. However, **if you want to listen through the speakers connected to the AV receiver, in addition to an HDMI connection, you'll also need to make a separate analog or digital audio connection.**

**Step 4: Assign the HDMI IN.**

Turn on the AV receiver, and then assign the HDMI IN (see page 38)

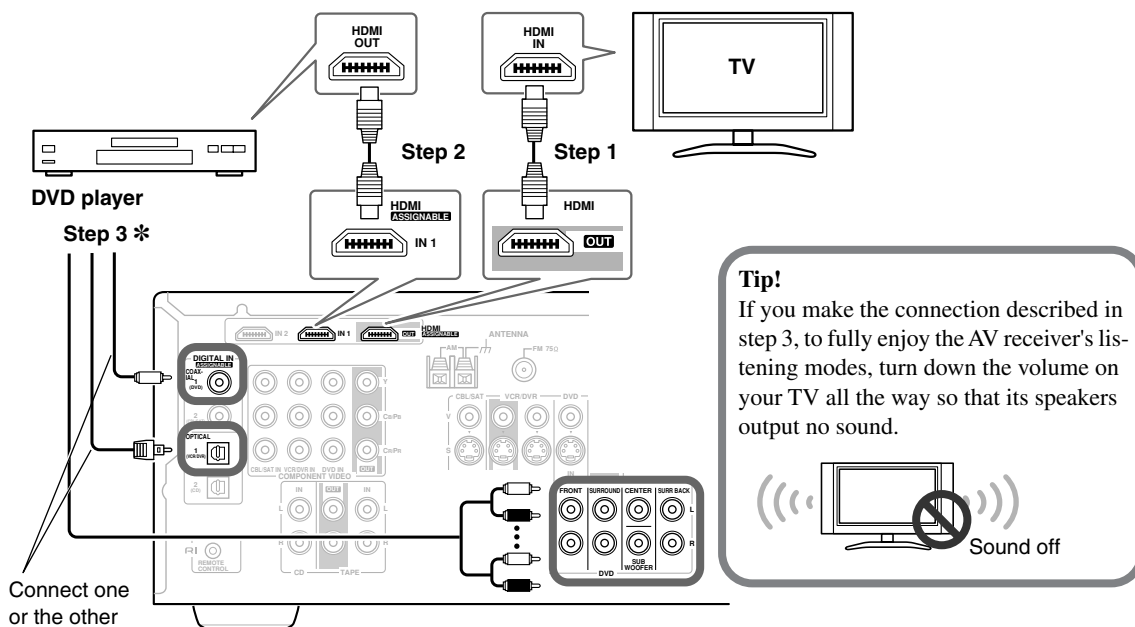

#### Notes:

- Audio and video signals received via the HDMI IN jacks are output only by the HDMI OUT.
- Audio and video signals received via inputs other than the HDMI IN jacks are not output by the HDMI OUT.
- The HDMI video stream is compatible with DVI (Digital Visual Interface), so TVs and displays with a DVI input can be connected by using an HDMI-to-DVI adapter cable. (Note that DVI connections only carry video, so you'll need to make a separate connection for audio.) However, reliable operation with such an adapter is not guaranteed. In addition, video signals from a PC are not supported.
- To watch an HDMI source that's connected via the AV receiver's HDMI jacks, the AV receiver must be turned on, otherwise no HDMI signal will be output.
- The HDMI audio signal (sampling rate, bit length, etc.) may be restricted by the connected source component. If the picture is poor or there's no sound from a component connected via HDMI, check its setup. Refer to the connected component's instruction manual for details.

## Connecting Your Components—Continued

### Connecting a VCR or DVD Recorder for Playback



With this hookup, you can use your VCR's tuner to listen to your favorite TV programs via the AV receiver, useful if your TV has no audio outputs.

#### Step 1: Choose a video connection from **A**, **B**, and **C**.

**TX-SR505/TX-SR505E/TX-SR8550:** You must connect the AV receiver to your TV via the same type of connection.

#### Step 2: Choose an audio connection from **a**, **b**, and **c**.

- With connection **a**, you can listen to the VCR or DVD recorder even via speaker set B.
- To enjoy Dolby Digital and DTS, use connection **b** or **c**. (To listen via speaker set B, use **a** and **b**, or **a** and **c**.)

Connection	AV receiver	Signal flow	VCR or DVD recorder	Picture quality
<b>A</b>	COMPONENT VIDEO VCR/DVR IN (TX-SR505/TX-SR505E/TX-SR8550) or COMPONENT VIDEO IN 2 (TX-SR575)	←	Component video output	Best
<b>B</b>	VCR/DVR IN S	←	S-Video output	Better
<b>C</b>	VCR/DVR IN V	←	Composite video output	Standard
<b>a</b>	VCR/DVR IN L/R	←	Analog audio L/R output	
<b>b</b>	DIGITAL IN COAXIAL 2	←	Digital coaxial output	
<b>c</b>	DIGITAL IN OPTICAL 1	←	Digital optical output	

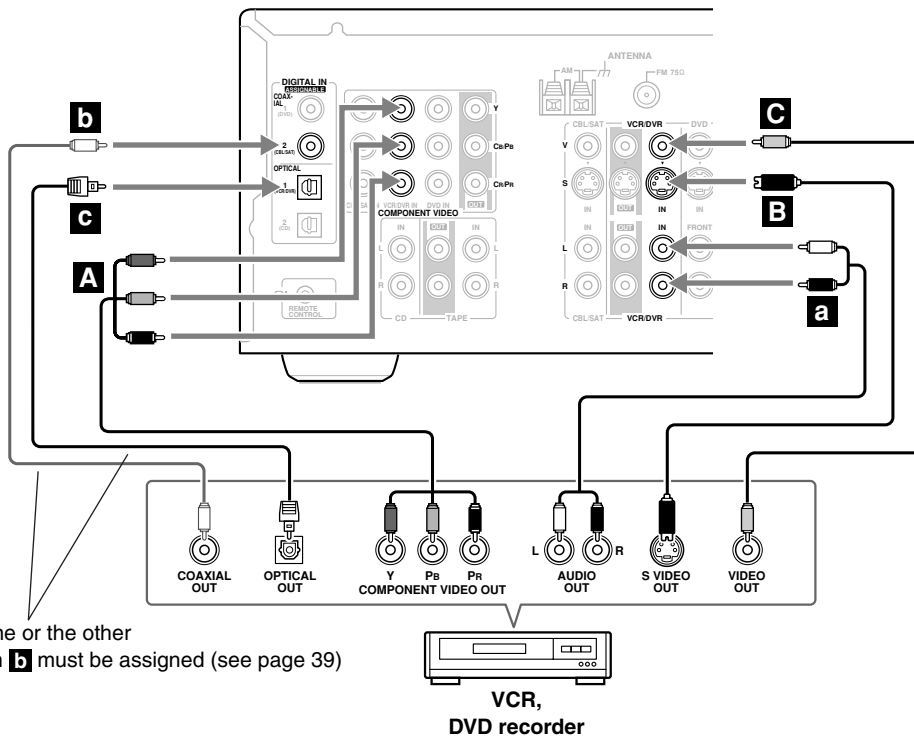

## Connecting Your Components—Continued

### Connecting a VCR or DVD Recorder for Recording

**Step 1: Choose a video connection from **A** and **B**.**

**TX-SR505/TX-SR505E/TX-SR8550:** The video source to be recorded must be connected to the AV receiver via the same type of connection.

**Step 2: Make the audio connection **a**.**

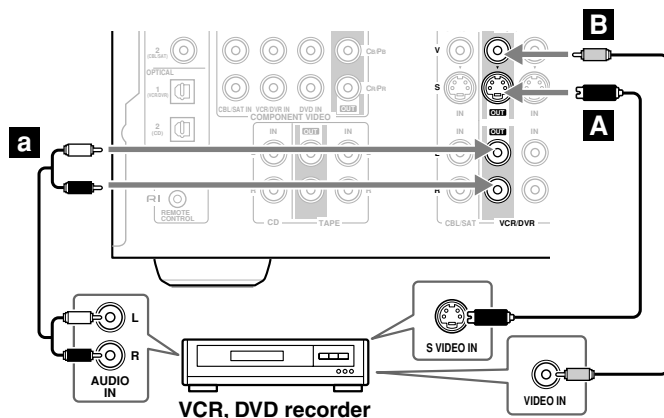

Connection	AV receiver	Signal flow	VCR or DVD recorder	Picture quality
<b>A</b>	VCR/DVR OUT S	⇒	S-Video input	Better
<b>B</b>	VCR/DVR OUT V	⇒	Composite video input	Standard
<b>a</b>	VCR/DVR OUT L/R	⇒	Analog audio L/R input	—

### Connecting a Camcorder, Games Console, or Other Device

**Step 1: Make the video connection **A**.**

**Step 2: Make the audio connection **a**.**

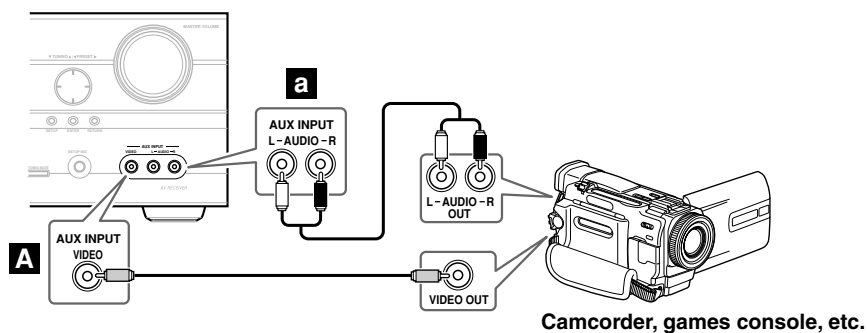

Connection	AV receiver	Signal flow	Camcorder or console
<b>A</b>	AUX INPUT VIDEO	←	Composite video output
<b>a</b>	AUX INPUT L-AUDIO-R	←	Analog audio L/R output

## Connecting Your Components—Continued

### Connecting a Satellite, Cable, Set-top box, or Other Video Source



With this hookup, you can use your satellite or cable receiver to listen to your favorite TV programs via the AV receiver, useful if your TV has no audio outputs.

#### Step 1: Choose a video connection from **A**, **B**, and **C**.

**TX-SR505/TX-SR505E/TX-SR8550:** You must connect the AV receiver to your TV via the same type of connection.

#### Step 2: Choose an audio connection from **a**, **b**, and **c**.

- With connection **a**, you can listen to and record audio from the video source and listen via speaker set B.
- To enjoy Dolby Digital and DTS, use connection **b** or **c**. (For recording, use **a** and **b**, or **a** and **c**.)

Connection	AV receiver	Signal flow	Video source	Picture quality
<b>A</b>	COMPONENT VIDEO CBL/SAT IN (TX-SR505/TX-SR505E/TX-SR8550) or COMPONENT VIDEO IN 3 (TX-SR575)	←	Component video output	Best
<b>B</b>	CBL/SAT IN S	←	S-Video output	Better
<b>C</b>	CBL/SAT IN V	←	Composite video output	Standard
<b>a</b>	CBL/SAT IN L/R	←	Analog audio L/R output	
<b>b</b>	DIGITAL IN COAXIAL 2	←	Digital coaxial output	
<b>c</b>	DIGITAL IN OPTICAL 1	←	Digital optical output	

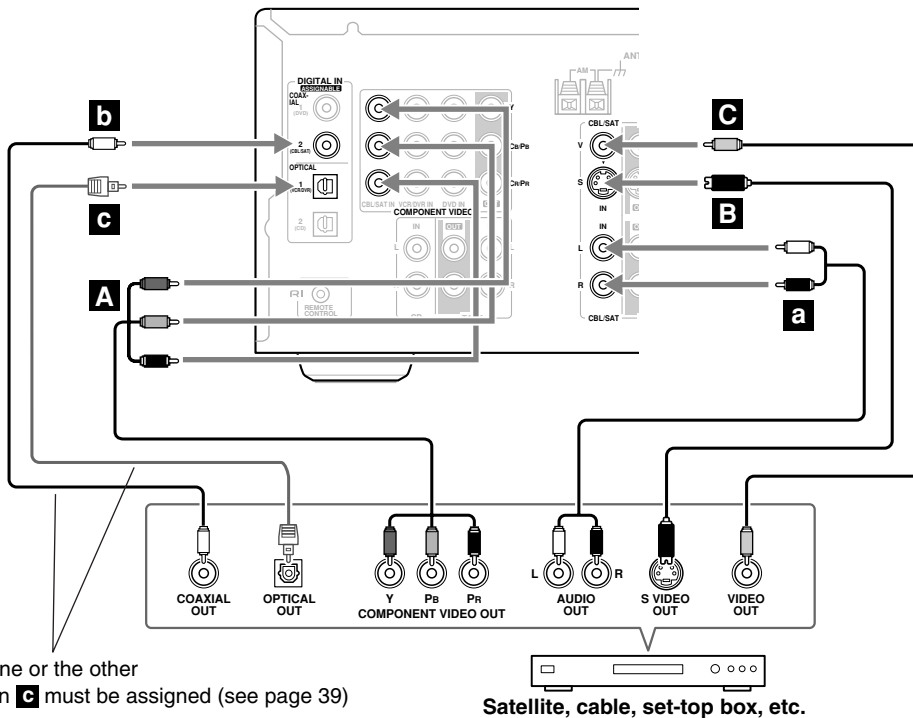

# Connecting Your Components—Continued

## Connecting a CD Player or Turntable

### ■ CD Player or Turntable (MM) with Built-in Phono Preamp

#### Step 1:

Choose a connection that matches your CD player (a, b, or c). Use connection a for a turntable with a built-in phono preamp.

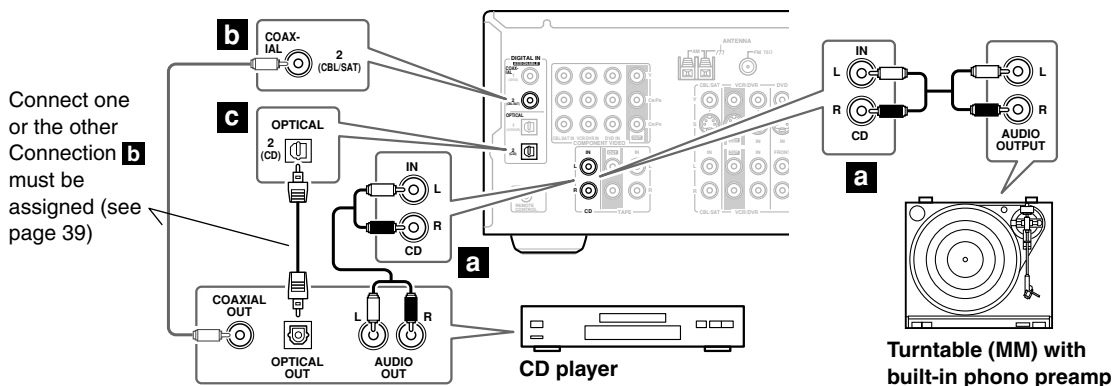

- With connection a, you can listen to and record audio from your CD player or turntable and listen via speaker set B.
- To connect the CD player digitally, use connection b or c. (For recording, use a and b, or a and c.)

Connection	AV receiver	Signal flow	CD or turntable
<b>a</b>	CD IN L/R	←	Analog audio L/R output
<b>b</b>	DIGITAL IN COAXIAL 2	←	Digital coaxial output
<b>c</b>	DIGITAL IN OPTICAL 2	←	Digital optical output

### ■ Turntable (MM) with no Phono Preamp Built-in

A phono preamp is necessary to connect a turntable that doesn't have a phono preamp built-in.

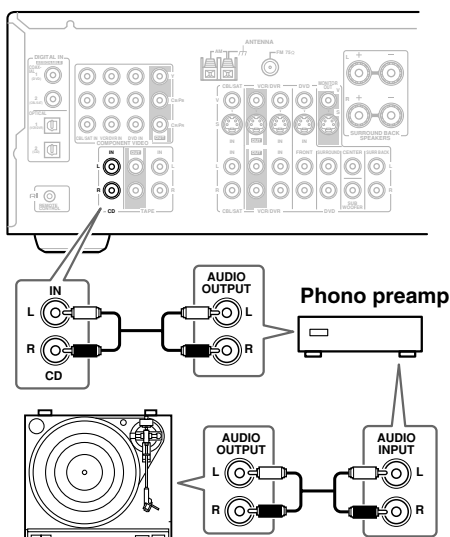

### ■ Turntable with an MC (Moving Coil) Cartridge

An MC head amp and phono preamp are necessary to connect a turntable with an MC (Moving Coil) cartridge.

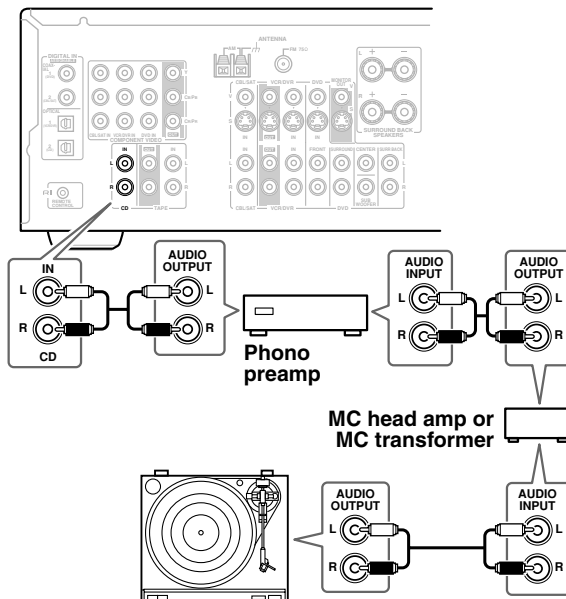

## Connecting an RI Dock

### RI Dock with video

Connect your RI Dock's analog audio output jacks and S-Video output jack to the AV receiver's CBL/SAT IN L/R jacks and CBL/SAT IN S jack.

### RI Dock without video

Connect your RI Dock's analog audio output jacks to the AV receiver's TAPE IN L/R jacks (1).

#### Notes:

- Connect the Remote Interactive Dock with an **RI** cable (see page 33).
- Set the Remote Interactive Dock's RI MODE switch to HDD or HDD/DOCK.
- Set the AV receiver's Input Display to DOCK (see page 39).
- Refer to the Remote Interactive Dock's instruction manual.

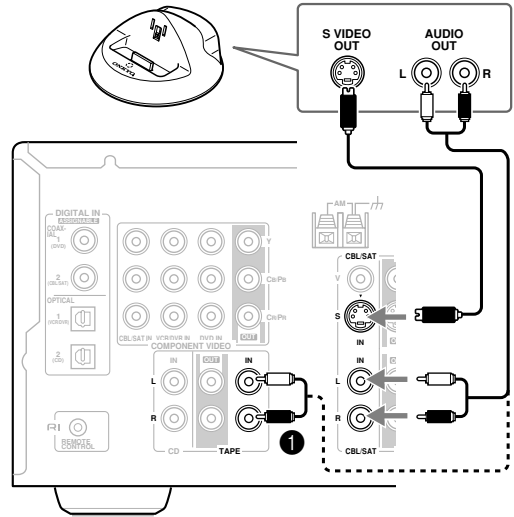

(DS-A1 hookup shown here.)

## Connecting a Cassette, CDR, MiniDisc, or DAT Recorder

### Step 1:

Choose a connection that matches the recorder (**a**, **b**, or **c**), and then make the connection.

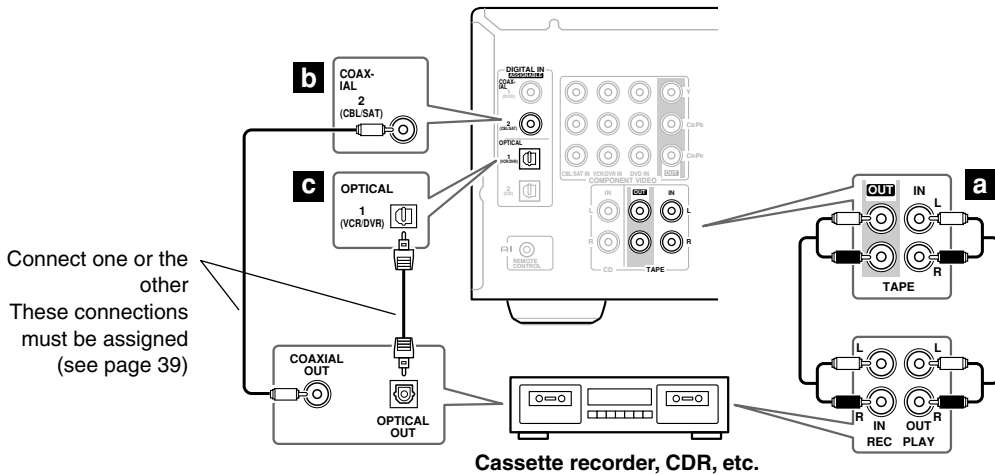

- With connection **a**, you can listen via speaker set B.
- To connect the recorder digitally, use connections **a** and **b**, or **a** and **c**.

Connection	AV receiver	Signal flow	Cassette/CDR/MD/DAT recorder
<b>a</b>	TAPE IN L/R TAPE OUT L/R	← →	Analog audio L/R output Analog audio L/R input
<b>b</b>	DIGITAL IN COAXIAL 2	←	Digital coaxial output
<b>c</b>	DIGITAL IN OPTICAL 1	←	Digital optical output



### Connecting Onkyo RI Components

**Step 1:** Make sure that each Onkyo component is connected to the AV receiver with an analog audio cable (connection **a** in the hookup examples) (see pages 25 to 32).

**Step 2:** Make the **RI** connection.

**Step 3:** If you're using an MD, CDR, or RI Dock, change the input Display (see page 39).

With **RI** (Remote Interactive), you can use the following special functions:

#### ■ Auto Power On/Standby

When you start playback on a component connected via **RI**, if the AV receiver is on Standby, it will automatically turn on and select that component as the input source. Similarly, when the AV receiver is set to Standby, all components connected via **RI** will also go on Standby. This function will not work on components connected to an AC OUTLET on the AV receiver.

#### ■ Direct Change

When playback is started on a component connected via **RI**, the AV receiver automatically selects that component as the input source. If your DVD player is connected to the AV receiver's multichannel DVD input, you'll need to press the [MULTI CH] button to hear all channels (see page 41), as the Direct Change **RI** function only selects the FRONT DVD IN jacks.

#### ■ Remote Control

You can use the AV receiver's remote controller to control your other **RI**-capable Onkyo components, pointing the remote controller at the AV receiver's remote control sensor instead of the component. You must enter the appropriate remote control code first (page 63).

#### Notes:

- Use only **RI** cables for **RI** connections. **RI** cables are supplied with Onkyo players (DVD, CD, etc.).
- Some components have two **RI** jacks. You can connect either one to the AV receiver. The other jack is for connecting additional **RI**-capable components.
- Connect only Onkyo components to **RI** jacks. Connecting other manufacturer's components may cause a malfunction.
- Some components may not support all **RI** functions. Refer to the manuals supplied with your other Onkyo components.

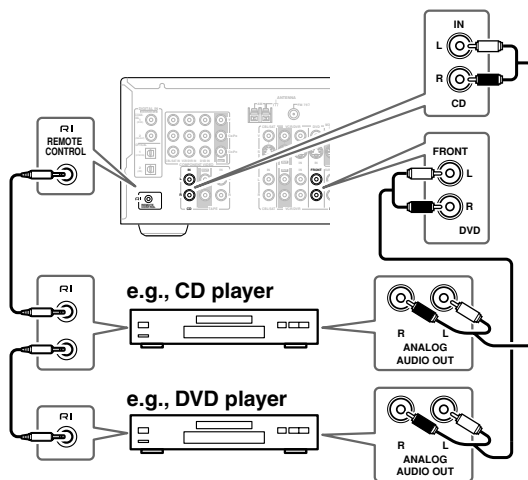

### Connecting the Power Cord

- Connect the AV receiver's power cord to a suitable wall outlet.

#### Notes:

- **Before connecting the power cord, connect all of your speakers and AV components.**
- Turning on the AV receiver may cause a momentary power surge that might interfere with other electrical equipment on the same circuit. If this is a problem, plug the AV receiver into a different branch circuit.

# Turning On the AV Receiver

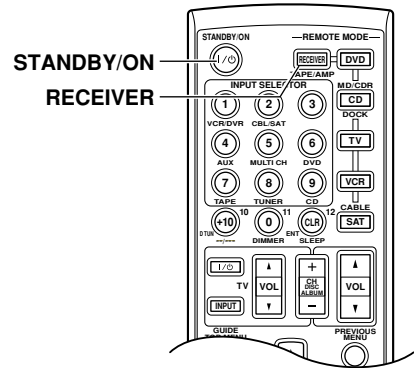
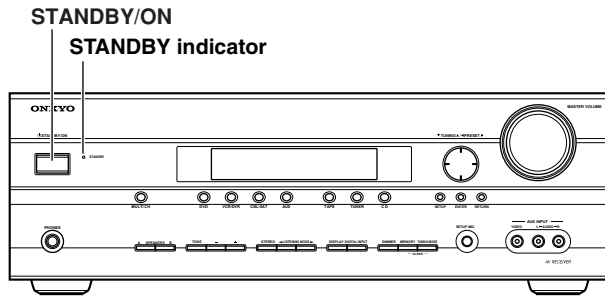

## Turning On and Standby

1

AV receiver



or

Remote controller



Press the [STANDBY/ON] button.

Alternatively, press the remote controller's [RECEIVER] button, followed by the [STANDBY/ON] button.

The AV receiver comes on, the display lights up, and the STANDBY indicator goes off.

To turn the AV receiver off, press the [STANDBY/ON] button again. The AV receiver will enter Standby mode. To prevent any loud surprises when you next turn on the AV receiver, always turn down the volume before you turn it off.

## Smooth Operation in a Few Easy Steps

To ensure smooth operation, here's a few easy steps to help you configure the AV receiver before you use it for the very first time. These settings only need to be made once.

### ■ Do the automatic speaker setup—this is essential!

See "Automatic Speaker Setup (Audyssey 2EQ)" on page 35.



If you've connected any speakers with an impedance of between 4 and 6 ohms, see "Minimum Speaker Impedance Setup" on page 35 before the automatic speaker setup (not North American model).

### ■ For TX-SR505 North American model/TX-SR505E/TX-SR575 Have you connected a component to an HDMI IN or the COMPONENT VIDEO IN (TX-SR575 only)?

If you have, see "Video Input Setup" on page 38.

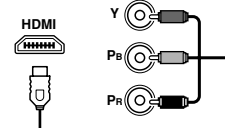

### ■ Have you connected a component to a digital audio input?

If you have, see "Digital Audio Input Setup" on page 39.

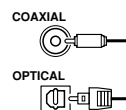

### ■ Have you connected an Onkyo MD recorder, CD recorder, or RI Dock?

If you have, see "Changing the Input Display" on page 39.



CD recorder, MD recorder,  
RI Dock

# First Time Setup

This section explains the settings that you need to make before using the AV receiver for the very first time.

## Automatic Speaker Setup (Audyssey 2EQ)

With the supplied speaker setup microphone, the Audyssey 2EQ function can measure the number of speakers connected, their sizes, crossover frequencies, and distances from the listening position, and then calculate the optimal speaker settings for your listening environment.

Before using this function, connect and position all of your speakers.

If any of your speakers are 4 ohms, change the minimum speaker impedance setting below before running the automatic speaker setup (not north American model).

## Minimum Speaker Impedance Setup (not North American model)

If the impedance of any of the connected speakers is 4 ohms or more but less than 6, set the minimum speaker impedance to 4 ohms.

### Note:

Before you change this setting, turn down the volume.

- 1** Press the [RECEIVER] button, followed by the remote controller's [SETUP] button.
- 2** Use the Up and Down [▲]/[▼] buttons to select "0. Hardware Setup," and then press [ENTER].
- 3** Use the Left and Right [◀]/[▶] buttons to select the setting for "Impedance."  
**4 ohms:** Select if the impedance of any connected speaker is 4 ohms or more but less than 6.  
**6 ohms:** Select if the impedances of all connected speakers are between 6 and 16 ohms.
- 4** Press the [SETUP] button.  
Setup closes.

## Measurement Points

To create a listening area in which several people can enjoy home theater simultaneously, the Audyssey 2EQ function takes measurements at three points within the listening area:

- ① First measurement point**  
This is the center point of the listening area, or the listening position if it's just one person.
- ② Second measurement point**  
The right side of the listening area.
- ③ Third measurement point**  
The left side of the listening area.

The distances between points ① and ② and points ① and ③ must be at least 1 meter.

From the examples below, choose the listening area that best matches yours and place the microphone accordingly when prompted.

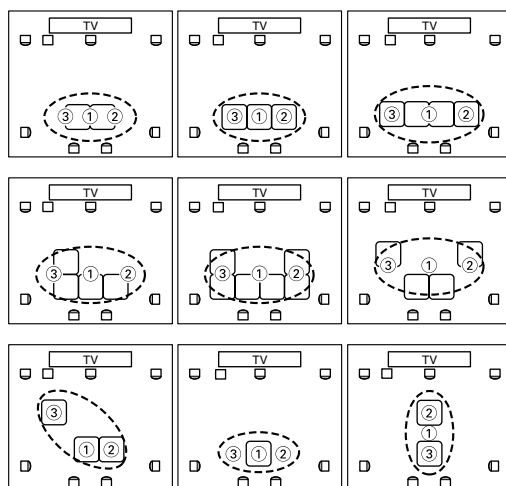

- : Listening area  
□ : Listening position

Using Audyssey 2EQ

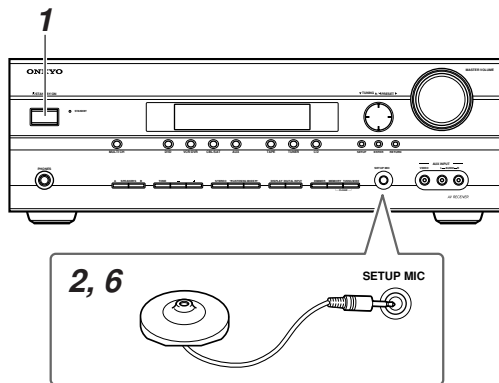

- 1 Turn on the AV receiver.**
- 2 Put the speaker setup microphone at measurement point ① (page 35), and connect it to the SETUP MIC jack.**

SETUP MIC

**Notes:**

  - Make sure the microphone is horizontal.
  - If there's an obstacle between the microphone and any speaker, the automatic setup will not work correctly. Set up the room as you would when enjoying a DVD.
  - Positioning the microphone close to where your ears would normally be will provide better results. You can adjust the height of the microphone by using a tripod or level table.
- 3 Press [ENTER].**

The automatic speaker setup starts.

A test tone is output by each speaker in turn, as the Audyssey 2EQ function determines which speakers are connected. This takes a few minutes.

**Note:**

  - If any extraneous noise is picked up by the microphone, the automatic setup may not work correctly, so don't make any noise.

**Notes:**

- If the AV receiver was previously muted, it will be unmuted.
- Automatic speaker setup cannot be performed while a pair of headphones is connected.
- It takes about 10 minutes to complete the automatic speaker setup.

- 4 When the following display appears, move the speaker setup microphone to measurement point ② (page 35), and then press [ENTER].**

Audyssey 2EQ performs more measurements. This takes a few minutes.
- 5 When the following display appears, move the speaker setup microphone to measurement point ③ (page 35), and then press [ENTER].**

Audyssey 2EQ performs more measurements. This takes a few minutes.

When the measurements are complete, the results are calculated and saved automatically.
- 6 When the automatic speaker setup is complete, disconnect the speaker setup microphone.**

**Notes:**

- When the automatic speaker setup is complete, the Equalizer Settings (page 60) will be set to “Audyssey.”
- You can cancel the automatic speaker setup at any point in this procedure simply by disconnecting the setup microphone.

### Error Messages

While the automatic speaker setup is in progress, one of the following error messages may appear:

**Ambient noise is too high**

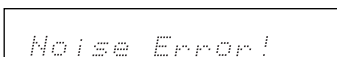

This message appears if there's too much background noise and the measurements cannot be performed properly. Remove the source of the noise and try again.

**Speaker Detect Errors**

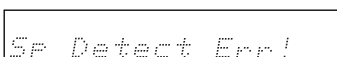

This message appears if one of the speaker-related errors below occurs.

- One of the front speakers has not been detected.
- One of the surround speakers has not been detected.
- The surround back speakers have been detected but the surround speakers haven't.
- The right surround back speaker has been detected but the left surround back speaker hasn't.
- The number of speakers detected on the second or third measurement was different to the number detected on the first measurement.

**Write Error**

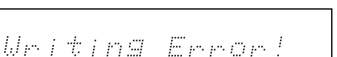

This message appears if saving fails.

### To Retry the Automatic Speaker Setup

**Press the [ENTER] button.**  
Make sure speakers that cannot be detected are connected properly.



### Changing the Speaker Settings Manually

In some situations, the measurements taken by the automatic speaker setup may not provide usable results. If running the speaker setup a second time still doesn't provide usable results, you'll have to set the speaker settings manually (see pages 56–60).

### Using a Powered Subwoofer

If you're using a powered subwoofer, because it outputs very low-frequency sound and its position is usually low down, it may not be detected by the automatic speaker setup. In this case, increase the subwoofer's volume, set it to its highest crossover frequency, and then try running the automatic speaker setup again. Note that if the volume is set too high and the sound distorts, it may not be detected, so use an appropriate volume level. If the subwoofer has a low-pass filter switch, set it to Off or Direct. Refer to your subwoofer's instruction manual for details.

**TX-SR505 North American Model/TX-SR505E/TX-SR575 Only**

**Video Input Setup**

If you connect a video component to a COMPONENT VIDEO IN or HDMI IN, use this setting to assign that input to an input selector. If you have a TX-SR505 other than North American model/TX-SR550, skip this page.

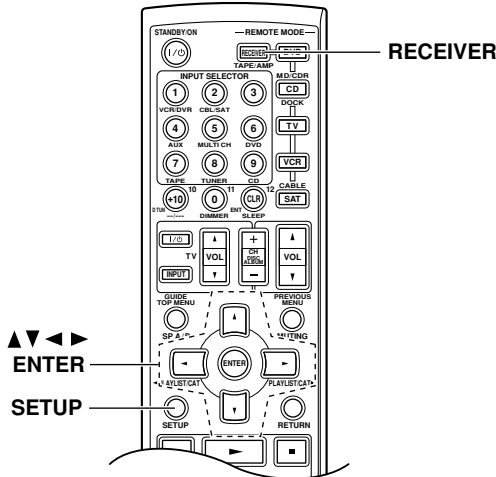

**4** Press the [SETUP] button. Setup closes.

**1** Press the [RECEIVER] button, followed by the [SETUP] button.

**2** Use the Up and Down [▲]/[▼] buttons to select "Video Input," and then press [ENTER].

Video Input

**3** Use the Up and Down [▲]/[▼] buttons to select "Component Video Setup" (TX-SR575 only) or "HDMI Video Setup" and use the Left and Right [◀]/[▶] buttons to change the setting. See the right column for setting details.

CMPNT DVD: IN1

Component Input  
video

HDMI DVD: No

HDMI Input  
video

**Component Video Setup (TX-SR575 only)**

If you connect a video component to a COMPONENT VIDEO IN, you must assign that input to an input selector. For example, if you connect your DVD player to COMPONENT VIDEO IN 3, you must assign CMPNT DVD setting to IN3.

If you want to output composite video and S-Video sources from the COMPONENT VIDEO OUT, select Upcnv.

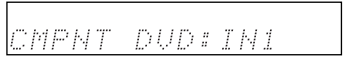

- IN1:** Select if the video component is connected to COMPONENT VIDEO IN 1.
- IN2:** Select if the video component is connected to COMPONENT VIDEO IN 2.
- IN3:** Select if the video component is connected to COMPONENT VIDEO IN 3.

**Upcnv:** Select to upconvert and output composite video or S-Video sources from the COMPONENT VIDEO OUT.

**Note:**  
**TX-SR575 only:** When IN1, IN2, or IN3 is selected, the composite video to S-Video and S-Video to composite video conversions do not work.

**HDMI Video Setup (TX-SR505 North American model/TX-SR505E/TX-SR575 only)**

If you connect a video component to HDMI IN 1 or 2, you must assign that input to an input selector. For example, if you connect your DVD player to HDMI IN 1, you must assign HDMI DVD setting to IN1.

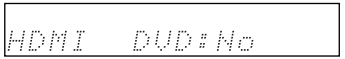

- IN1:** Select if the video component is connected to HDMI IN 1.
- IN2:** Select if the video component is connected to HDMI IN 2.
- No:** Select if you're not using the HDMI OUT.

### Digital Audio Input Setup

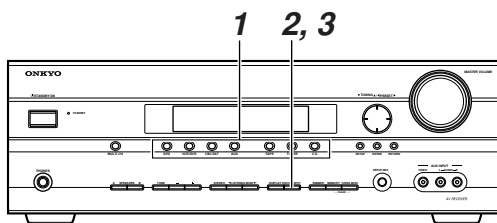

To enjoy Dolby Digital and DTS, you must connect your DVD player to the AV receiver digitally (coaxial or optical).

These are the default digital audio input assignments.

Input selector	Default assignment
DVD	COAX 1
VCR/DVR	OPT 1
CBL/SAT	COAX 2
TAPE	----
CD	OPT 2
AUX	----

You can change the digital audio input assignments if necessary. For example, if you connect your DVD player to the OPTICAL 1 DIGITAL IN (OPT1), you must assign that input to the DVD input selector, as follows.

**1**

**Press the input selector button for the input selector that you want to assign.**  
(Digital inputs cannot be assigned to the TUNER input selector.)

**2**

**Press the [DIGITAL INPUT] button.**  
The current assignment appears.

DVD                   #COAX1

**3**

**Press the [DIGITAL INPUT] button repeatedly to select COAX1, COAX2, OPT1, OPT2, or “----” (analog).**

DVD                   #OPT1

**Note:**

Make sure that components connected digitally are configured to output digital audio. Refer to the relevant manuals.

### Changing the Input Display

If you connect an **RI**-capable Onkyo MiniDisc recorder, CD recorder, or RI Dock to the TAPE IN/OUT or CBL/SAT IN jacks, for **RI** to work properly, you must change this setting.

This setting can only be changed on the AV receiver.

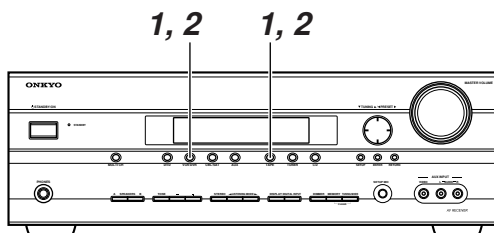

**1**

**Press the [TAPE] or [CBL/SAT] input selector button so that “TAPE” or “CBL/SAT” appears on the display.**

or

TAPE

or

CBL/SAT

**2**

**Press and hold down the [TAPE] or [CBL/SAT] input selector button (about 2 seconds) to change the setting.**

Repeat this step to select MD, CDR, or DOCK.

For the TAPE input selector, the setting changes in this order:

TAPE → MD → CDR → DOCK

↑

For the CBL/SAT input selector, the setting changes in this order:

CBL/SAT ↔ DOCK

**Note:**

DOCK can be selected for the TAPE input selector or CBL/SAT input selector, but not both at the same time.

# Playing Your AV Components

## Basic AV Receiver Operation

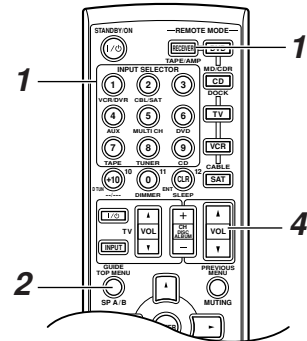
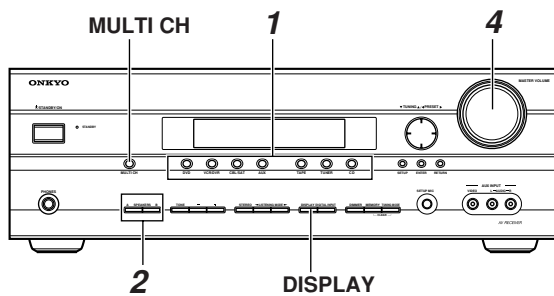

- 1**

**AV receiver**

**Remote controller**

**Use the AV receiver's input selector buttons to select the input source.**

To select the input source with the remote controller, press the [RECEIVER] REMOTE MODE button, and then use the INPUT SELECTOR buttons.
- 2**

**AV receiver**

**Remote controller**

**To turn the speakers on or off, use the AV receiver's SPEAKERS [A] and [B] buttons, or use the remote controller's [SP A/B] button.**

Pressing the remote controller's [SP A/B] button cycles through the following settings: Speaker Set A → Speaker Set A&B → Speaker Set B → Off.

Note that while speaker set B is on, speaker set A is reduced to 5.1-channel playback.

A
B
Indicators

See page 6 for more information about speaker sets A and B.
- 3**

**Start playback on the source component.**

To watch a DVD or other video source, on your TV, select the video input that's connected to the AV receiver's MONITOR OUT jack.

**TX-SR505 North American model/TX-SR505E/TX-SR575 only:** If your TV is connected to the HDMI OUT, see the tip on page 27.
- 4**

**AV receiver**

**Remote controller**

**To adjust the volume, use the MASTER VOLUME control, or the remote controller's [VOL] button.**

The volume can be set to MIN, 1 through 79, or MAX. Since the AV receiver is designed for home theater enjoyment, it has a wide volume range for precise adjustment.
- 5**

**Select a suitable listening mode and enjoy!**

See "Using the Listening Modes" on page 48.



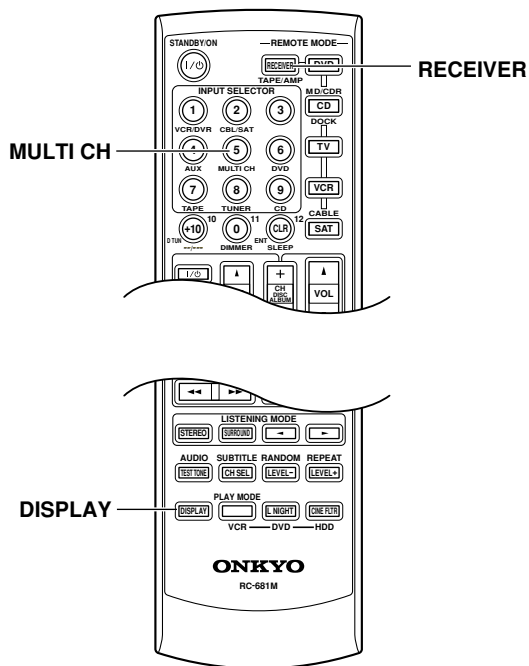

## Using the Multichannel DVD Input

The multichannel DVD input is for connecting a component with a 7.1-channel analog audio output, such as a DVD-Audio or SACD-capable DVD player, or an MPEG decoder. See page 26 for hookup information.



**Press the [RECEIVER] REMOTE MODE button, followed by the [MULTI CH] button.**

The MULTI CH indicator appears on the display.

MULTI CH indicator

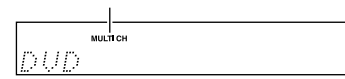

Audio from the multichannel DVD input will now be used for the DVD input source.

### Note:

- While the multichannel DVD input is selected, the Speaker Configuration settings on page 56 are ignored, and signals from the multichannel input are fed to the speakers as they are.

## Displaying Source Information

You can display various information about the current input source as follows.

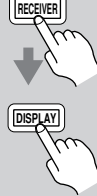

**Press the [RECEIVER] REMOTE MODE button, and then press the [DISPLAY] button repeatedly to cycle through the available information.**

The following information can typically be displayed:

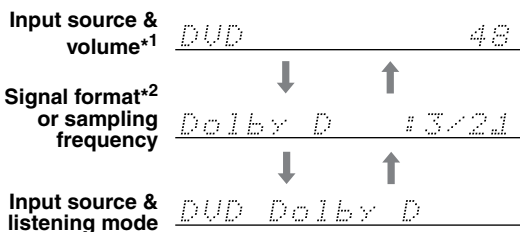

- \*1 When AM or FM radio is used, the band, preset number, and frequency are displayed.
- \*2 If the input signal is analog, or AM or FM radio is selected, no format information is displayed. If the input signal is PCM, the sampling frequency is displayed. If the input signal is digital but not PCM, the signal format is displayed. Information is displayed for about 3 seconds, then the previous display reappears.

### Note:

- The listening mode is displayed only when speaker set A is on.

## Interpreting Surround Channel Information

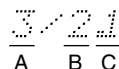

- A: The number of front channels (front left, front right, and center).
- B: The number of surround channels (surround left and surround right). If there's surround back channel information, this number will be 3.
- C: LFE channel for subwoofer (1 means yes).

# Listening to the Radio

## Listening to AM/FM Stations

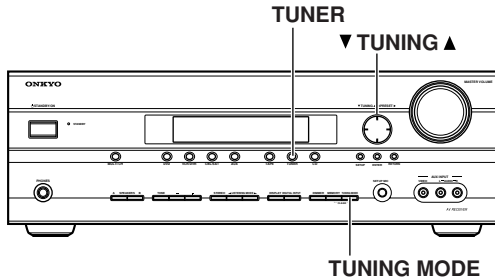

With the built-in tuner, you can enjoy AM and FM radio stations.

**1** Use the [TUNER] input selector button to select AM or FM. In this example, FM has been selected.

**TUNER**

Band Frequency

(Actual display depends on country.)

### AM Frequency Step Setup (not North America and Europe)

You must specify the AM frequency step used in your area. Note that when this setting is changed, all radio presets are deleted.

- 1** Press the [SETUP] button, use the Up and Down [▲]/[▼] buttons to select “0. Hardware Setup,” and then press [ENTER].
- 2** Use the Up and Down [▲]/[▼] buttons to select “AM Freq,” and then use the Left and Right [◀]/[▶] buttons to select:
  - 10 kHz:** Select if 10 kHz steps are used in your area.
  - 9 kHz:** Select if 9 kHz steps are used in your area.
- 3** Press the [SETUP] button. Setup closes.

## Tuning into AM/FM Radio Stations

### Auto Tuning Mode

- 1** Press the [TUNING MODE] button so that the AUTO indicator appears on the display.
- 2** Press the TUNING Up or Down [▲]/[▼] button. Searching stops when a station is found.

### Manual Tuning Mode

- 1** Press the [TUNING MODE] button so that the AUTO indicator disappears from the display.
- 2** Press and hold the TUNING Up or Down [▲]/[▼] button. The frequency stops changing when you release the button. Press the buttons repeatedly to change the frequency one step at a time.

The American model changes FM frequency in 0.2 MHz steps, 10 kHz steps for AM. For other models it's 0.05 MHz steps for FM and 9 kHz (or 10 kHz) steps for AM.

When tuned into a station, the TUNED indicator appears. When tuned into a stereo FM station, the FM STEREO indicator also appears.

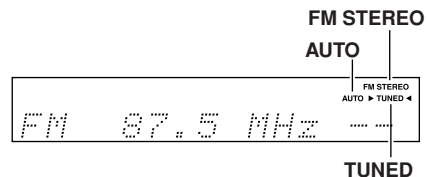

### Tuning into Weak FM Stereo Stations

If the signal from a stereo FM station is weak, it may be impossible to get good reception. In this case, switch to Manual Tuning mode and listen to the station in mono.

#### Note:

- You can also use the remote controller's Up and Down [▲]/[▼] buttons to tune the radio.

## Listening to the Radio—Continued

### ■ Tuning into Stations by Frequency

You can tune into AM and FM stations directly by entering the appropriate frequency.

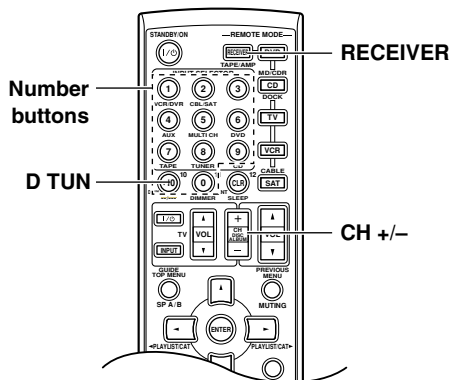

**1** Press the [RECEIVER] button, followed by the [D TUN] button.

(Actual display depends on country.)  
The [RECEIVER] button flashes.

**2** Within 8 seconds, use the number buttons to enter the frequency of the radio station.

For example, to tune to 87.5 (FM), press 8, 7, 5.

**Note:** While the [RECEIVER] button is flashing, the input source cannot be changed by using the remote controller.

### Presetting AM/FM Stations

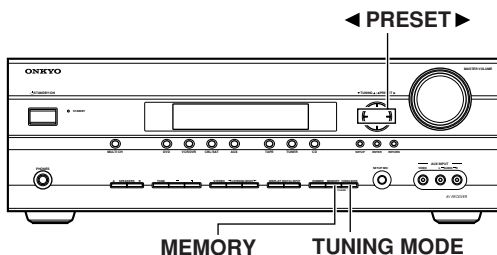

You can store a combination of up to 40 of your favorite AM/FM radio stations as presets.

**1** Tune into the AM/FM station that you want to store as a preset.

**2** Press the [MEMORY] button.  
The preset number flashes.

**3** While the preset number is flashing (about 8 seconds), use the PRESET [◀/▶] buttons to select a preset from 1 through 40.

**4** Press the [MEMORY] button again to store the station or channel.  
The station or channel is stored and the preset number stops flashing.  
Repeat this procedure for all of your favorite AM/FM radio stations.

### ■ Selecting Presets

**1** To select a preset, use the PRESET [◀/▶] buttons, or the remote controller's CH [+/-] button.

### ■ Deleting Presets

**1** Select the preset that you want to delete.  
See the previous section.

**2** While holding down the [MEMORY] button, press the [TUNING MODE] button.  
The preset is deleted and its number disappears from the display.

### Using RDS (European Models Only)

RDS only works with European models and only in areas where RDS broadcasts are available.

When tuned into an RDS station, the RDS indicator appears.

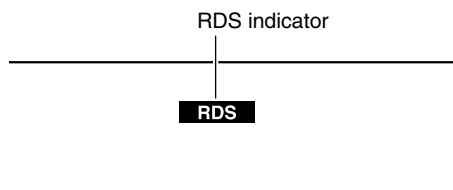

#### ■ What is RDS?

RDS stands for *Radio Data System* and is a method of transmitting data in FM radio signals. It was developed by the European Broadcasting Union (EBU) and is available in most European countries. Many FM stations use it these days. In addition to displaying text information, RDS can also help you find radio stations by type (e.g., news, sport, rock, etc.).

The AV receiver supports four types of RDS information:

#### **PS (Program Service)**

When tuned to an RDS station that's broadcasting PS information, the station's name will be displayed. Pressing the [DISPLAY] button will display the frequency for 3 seconds.

#### **RT (Radio Text)**

When tuned to an RDS station that's broadcasting text information, the text will be shown on the display (see page 45).

#### **PTY (Program Type)**

This allows you to search for RDS radio stations by type (see page 45).

#### **TP (Traffic Program)**

This allows you to search for RDS radio stations that broadcast traffic information (see page 45).

#### **Notes:**

- In some cases, the text characters displayed on the AV receiver may not be identical to those broadcast by the radio station. Also, unexpected characters may be displayed when unsupported characters are received. This is not a malfunction.
- If the signal from an RDS station is weak, RDS data may be displayed intermittently or not at all.

### RDS Program Types (PTY)

Type	Display
None	NONE
News reports	NEWS
Current affairs	AFFAIRS
Information	INFO
Sport	SPORT
Education	EDUCATE
Drama	DRAMA
Culture	CULTURE
Science and technology	SCIENCE
Varied	VARIED
Pop music	POP M
Rock music	ROCK M
Middle of the road music	EASY M
Light classics	LIGHT M
Serious classics	CLASSICS
Other music	OTHER M
Weather	WEATHER
Finance	FINANCE
Children's programmes	CHILDREN
Social affairs	SOCIAL
Religion	RELIGION
Phone in	PHONE IN
Travel	TRAVEL
Leisure	LEISURE
Jazz music	JAZZ
Country music	COUNTRY
National music	NATION M
Oldies music	OLDIES
Folk music	FOLK M
Documentary	DOCUMENT
Alarm test	TEST
Alarm	ALARM

## Displaying Radio Text (RT)

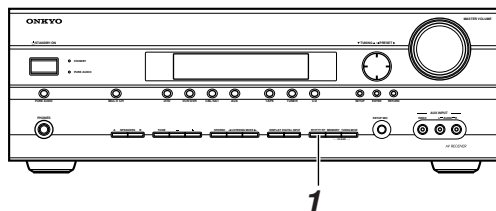

When tuned to an RDS station that's broadcasting text information, the text can be displayed.

**1**



**Press the [RT/PTY/TP] button once.**

The RT information scrolls across the display.

### Notes:

- The message “Waiting” may appear while the AV receiver waits for the RT information.
- If the message “No Text Data” appears on the display, no RT information is available.

## Finding Stations by Type (PTY)

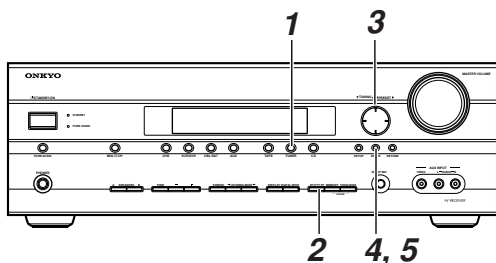

You can search for radio stations by type.

**1**



**Use the [TUNER] input selector button to select FM.**

**2**



**Press the [RT/PTY/TP] button twice.**

The current program type appears on the display.

**3**

▼ TUNING ▲ ◀ PRESET ▶



**Use the PRESET [◀/▶] buttons to select the type of program you want.**

See the table on page 44.

**4**



**To start the search, press [ENTER].**

The AV receiver searches until it finds a station of the type you specified, at which point it stops briefly before continuing with the search.

**5**



**When a station you want to listen to is found, press [ENTER].**

If no stations are found, the message “Not Found” appears.

## Listening to Traffic News (TP)

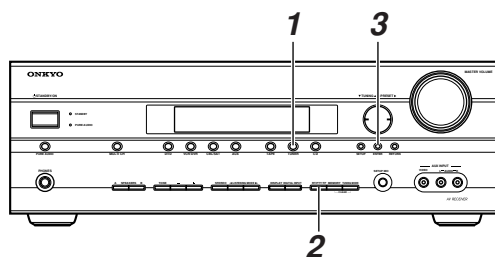

You can search for stations that broadcast traffic news.

**1**



**Use the [TUNER] input selector button to select FM.**

**2**

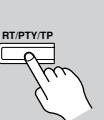

**Press the [RT/PTY/TP] button three times.**

If the current radio station is broadcasting TP (Traffic Program), “[TP]” will appear on the display, and traffic news will be heard as and when it's broadcast. If “TP” without square brackets appears, this means that the station is not broadcasting TP.

**3**



**To locate a station that is broadcasting TP, press [ENTER].**

The AV receiver searches until it finds a station that's broadcasting TP. If no stations are found, the message “Not Found” appears.

# Common Functions

This section explains functions that can be used with any input source.

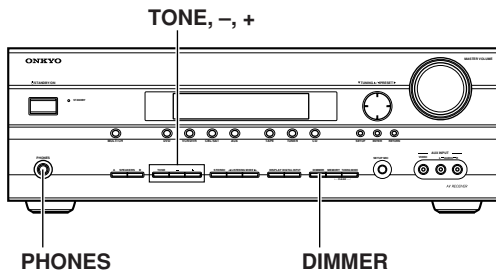
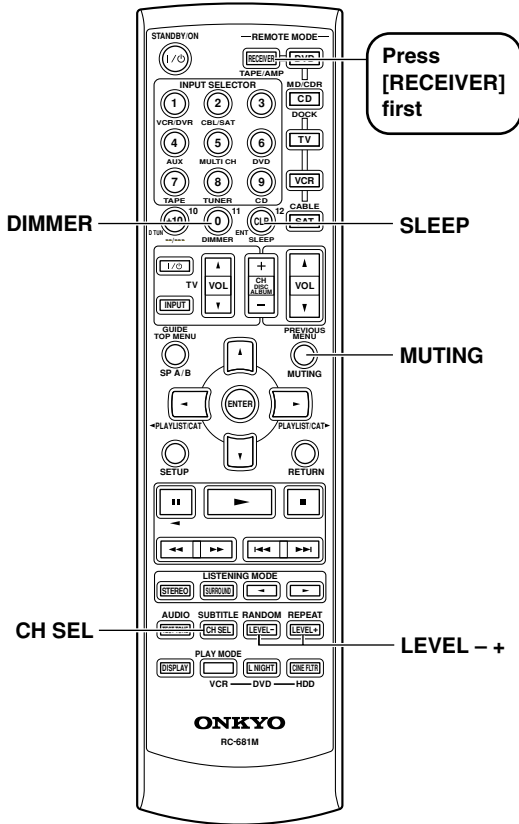

## Setting the Display Brightness

You can adjust the brightness of the display.



**Press the remote controller's [DIMMER] button repeatedly to select: dim, dimmer, or normal brightness.**

Alternatively, you can use the AV receiver's [DIMMER] button (not European models).

## Adjusting the Bass and Treble

You can adjust the bass and treble for the front speakers, except when the Direct or Pure Audio (not North American models) listening mode is selected.

**1** Press the AV receiver's [TONE] button repeatedly to select either Bass or Treble.

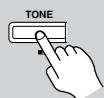

**2** Use the TONE [-]/[+] buttons to adjust.

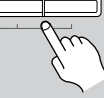

■ **Bass**  
You can boost or cut low-frequency sounds output by the front speakers from -10 dB to +10 dB in 2 dB steps.

■ **Treble**  
You can boost or cut high-frequency sounds output by the front speakers from -10 dB to +10 dB in 2 dB steps.

**Note:**

- To bypass the bass and treble tone circuits, select the Direct or Pure Audio (not North American model) listening mode.

## Muting the AV Receiver

You can temporarily mute the output of the AV receiver.



**Press the remote controller's [MUTING] button.**

The output is muted and the MUTING indicator flashes on the display.



**To unmute the AV receiver,** press the remote controller's [MUTING] button again, or adjust the volume. The output is unmuted and the MUTING indicator goes off. Muting is cancelled when the AV receiver is set to Standby.

### Using the Sleep Timer

With the sleep timer, you can set the AV receiver so that it turns off automatically after a specified period.



**Press the remote controller's [SLEEP] button repeatedly to select the required sleep time.**

You can set the sleep time from 90 to 10 minutes in 10 minute steps.

The SLEEP indicator appears on the display when the sleep timer has been set, as shown. The specified sleep time appears on the display for about 5 seconds, then the previous display reappears.

SLEEP indicator

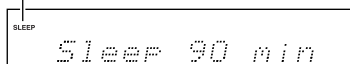

**To cancel the sleep timer,** press the [SLEEP] button repeatedly until the SLEEP indicator disappears.

**To check the remaining sleep time,** press the [SLEEP] button. Note that if you press the [SLEEP] button while the sleep time is being displayed, you'll shorten the sleep time by 10 minutes.

### Using Headphones

For private listening, you can connect a pair of stereo headphones (1/4-inch phone plug) to the AV receiver's PHONES jack.

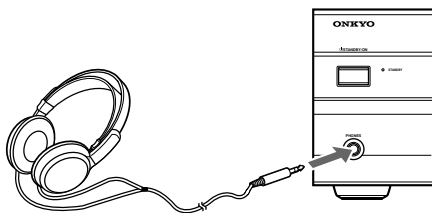

#### Notes:

- Always turn down the volume before connecting your headphones.
- Speaker sets A and B are turned off while the headphones plug is inserted in the PHONES jack.
- When you connect a pair of headphones, the listening mode is set to Stereo, unless it was set to Pure Audio, Mono, Stereo, or Direct, in which case it stays the same.
- When the multichannel DVD input is selected, only the front left and front right channels can be heard in the headphones.

### Adjusting Speaker Levels

You can adjust the volume of each speaker in speaker set A. These temporary adjustments are cancelled when the AV receiver is set to Standby.

1



**Use the remote controller's [CH SEL] button to select each speaker, and use the [LEVEL-] and [LEVEL+] buttons to adjust the volume.**

You can adjust the volume of each speaker from -12 dB to +12 dB (-15 dB to +12 dB for the subwoofer).



#### Notes:

- You cannot use this function while the AV receiver is muted.
- Speakers that are set to No or None in the Speaker Configuration cannot be adjusted.

#### ■ Speaker Set B

While speaker set B is on, you can adjust the volume of the left and right speakers, from -12 dB to +12 dB.

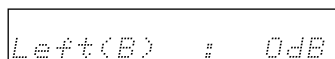

- These settings are stored when the AV receiver is set to Standby.
- While speaker set B is on, you cannot adjust the levels of speaker set A's surround back speakers.

#### ■ Headphones

While a pair of headphones is connected, you can adjust the volume of each headphone speaker, from -12 dB to +12 dB each.

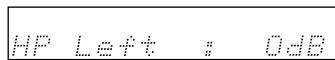

- These settings are stored when the AV receiver is set to Standby.

# Using the Listening Modes

## Selecting Listening Modes

For a description of each listening mode, see “About the Listening Modes” on page 50.

- The Dolby Digital and DTS listening modes can only be selected if your DVD player is connected to the AV receiver with a digital audio connection (coaxial or optical).
- Listening mode availability depends on the format of the current input signal.
- While a pair of headphones is connected, you can select only the Pure Audio (not North American model), Mono, Direct, or Stereo listening mode.
- The listening modes cannot be selected while speaker set A is off.

## Selecting on the AV Receiver

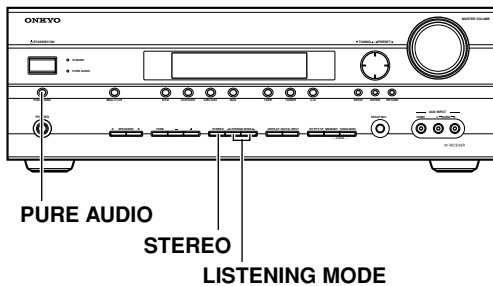

### ■ [PURE AUDIO] button (not North American model)

This button selects the Pure Audio listening mode. When this mode is selected, the AV receiver outputs no video signals and its display is turned off. Pressing this button again will select the previous listening mode.

**On the TX-SR505 North American model/TX-SR505E/TX-SR575**, video received at the HDMI IN is passed through to the HDMI OUT even if the Pure Audio listening mode is selected.

### ■ [STEREO] button

This button selects the Stereo listening mode.

### ■ LISTENING MODE [◀]/[▶] buttons

Pressing these buttons repeatedly cycles through all of the listening modes that can be used with the current input source.

## Selecting with the Remote Controller

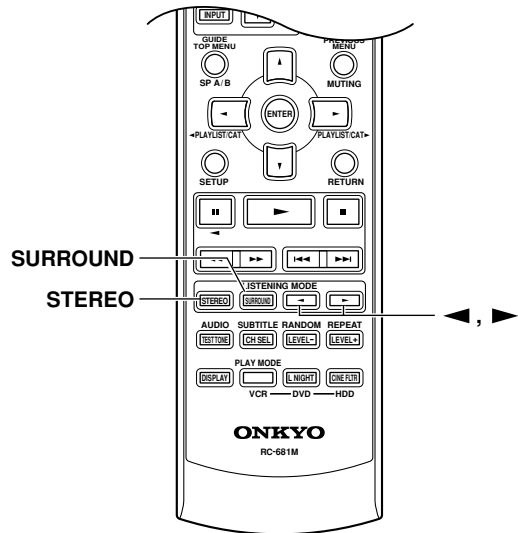

### ■ [STEREO] button

This button selects the Stereo listening mode.

### ■ [SURROUND] button

This button selects the Dolby Digital and DTS listening modes and the Neural Surround\* listening mode (\* TX-SR575 North American model only).

### ■ LISTENING MODE [◀]/[▶] buttons

Pressing these buttons repeatedly cycles through all of the listening modes that can be used with the current input source.



## Using the Listening Modes—Continued

The following table shows which listening modes can be used with each input signal format.

Source format		Analog, PCM <sup>*1</sup>	Dolby Digital				DTS/DTS 96/24 <sup>*2</sup>				Multich analog
			3/2.1 2/2.1	2/0	1/0, 1+1	Other	3/2.1 2/2.1	2/0	DTS-ES		
									Discrete	Matrix	
Listening mode		CD, TV, radio, cassette, etc.	DVD, DTV, etc.				DVD, CD, etc.				DVD
Pure Audio (Not North American models) Direct		✓	✓	✓	✓	✓	✓	✓	✓	✓	✓
Stereo Mono		✓	✓	✓	✓	✓	✓	✓	✓		
Multich											✓
PLIIx Movie/Music/Game <sup>*3</sup> Neo:6 Cinema Neo:6 Music		✓		✓				✓			
Neural Surround (TX-SR575 North American model only)		✓ <sup>*4</sup>									
Dolby	Dolby D		✓			✓					
	Dolby D + Neo:6 Dolby D EX Dolby D+PLIIx Music		✓								
	Dolby D+PLIIx Music		✓								
	Dolby D+PLIIx Movie		✓								
DTS	DTS, DTS 96/24					✓			✓ <sup>*5</sup>		
	DTS-ES Discrete							✓			
	DTS-ES Matrix								✓		
	DTS+Neo:6 DTS+Dolby EX DTS+PLIIx Music					✓					
	DTS+PLIIx Movie					✓					
T-D		✓	✓	✓	✓	✓	✓	✓	✓		
Onkyo Original DSP	Mono Movie Orchestra Unplugged Studio-Mix TV Logic All Ch Stereo Full Mono <sup>*6</sup>	✓	✓	✓	✓	✓	✓	✓	✓		

\*1. In the Pure Audio and Direct listening modes, 32 kHz, 44.1 kHz, and 48 kHz PCM is processed at 64 kHz, 88.2 kHz, and 96 kHz respectively. In listening modes other than Pure Audio, Direct, and Stereo, 64 kHz, 88.2 kHz, and 96 kHz PCM is processed at 32 kHz, 44.1 kHz, and 48 kHz respectively.

\*2. In listening modes other than Pure Audio, Direct, Stereo, and DTS 96/24, DTS 96/24 sources are processed as normal DTS.

\*3. If the Surr Back parameter is set to None, or speaker set B is on, normal Pro Logic II is used.

\*4. Not available for 88.2 kHz and 96 kHz PCM input signals.

\*5. If the Surr Back setting is set to None, or speaker set B is on, normal DTS is used.

\*6. Available only when surround speakers are connected.

■ : Only available on 6.1/7.1-channel playback systems. Not available while speaker set B is on.

■ : Only available on 7.1-channel playback systems. Not available while speaker set B is on.

**Tip:** To check the format of the digital input signal, see “Displaying Source Information” on page 41.

## About the Listening Modes

The AV receiver's listening modes can transform your listening room into a movie theater or concert hall, with high fidelity and stunning surround sound.

The illustration shows which speakers are active in each listening mode with 7.1 channel speaker system.

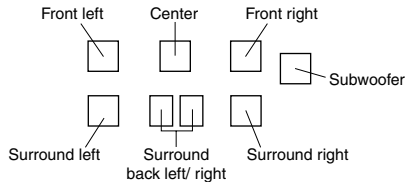

### Pure Audio (not North American models)

In this mode, the display and video circuitry are turned off, minimizing possible noise sources for the ultimate in high-fidelity reproduction. (As the video circuitry is turned off, no video signals are output in this mode.)

### Direct

In this mode, audio from the input source is output directly with minimal processing, providing high-fidelity reproduction. All of the source's audio channels are output as they are.

### Stereo

Sound is output by the front left and right speakers and subwoofer.

### Mono

Use this mode when watching an old movie with a mono soundtrack, or use it with the foreign language soundtracks recorded in the left and right channels of some movies. It can also be used with DVDs or other sources containing multiplexed audio, such as karaoke DVDs.

### Dolby Pro Logic IIx

### Dolby Pro Logic II

**Dolby Pro Logic IIx** expands any 2-channel source for 7.1-channel playback. It provides a very natural and seamless surround-sound experience that fully envelops the listener. As well as music and movies, video games can also benefit from the dramatic spatial effects and vivid imaging. If you're not using any surround back speakers, **Dolby Pro Logic II** will be used instead of Dolby Pro Logic IIx.

- **PLIIx Movie**  
Use this mode with any stereo or Dolby Surround (Pro Logic) movie (e.g., TV, DVD, VHS).
- **PLIIx Music**  
Use this mode with any stereo or Dolby Surround (Pro Logic) music source (e.g., CD, radio, cassette, TV, VHS, DVD).
- **PLIIx Game**  
Use this mode with video games, especially those that bear the Dolby Pro Logic II logo.

### Dolby Digital

Use this mode with DVDs that bear the  Dolby Digital logo, and Dolby Digital TV broadcasts. This is the most common digital surround-sound format, and it'll put you right in the middle of the action, just like being in a movie theater or concert hall.

### Dolby Digital EX DTS+Dolby EX

These modes expand 5.1-channel Dolby Digital and DTS sources for 6.1/7.1-channel playback. They're especially suited to Dolby Digital EX soundtracks that include a matrix-encoded surround back channel. The additional channel adds an extra dimension and provides an enveloping surround sound experience, perfect for rotating and fly-by sound effects. Use them with DVDs that bear the Dolby Digital or DTS logo.

### Dolby Digital+PLIIx Music DTS+PLIIx Music

These modes use the Pro Logic IIx Music mode to expand 5.1-channel Dolby Digital and DTS sources for 6.1/7.1-channel playback. Use them with Dolby Digital or DTS 5.1 music sources (e.g., DVD and Dolby Digital TV broadcasts).

### Dolby Digital+PLIIx Movie DTS+PLIIx Movie

These modes use the Pro Logic IIx Movie mode to expand 5.1-channel Dolby Digital and DTS sources for 7.1-channel playback. Use them with Dolby Digital and DTS 5.1 movies (e.g., DVD and select digital TV broadcasts).

### DTS

The DTS digital surround-sound format supports up to 5.1 discrete channels and uses less compression for high-fidelity reproduction. Use it with DVDs and CDs that bear the DTS logo.

### DTS 96/24

This mode is for use with DTS 96/24 sources. This is high-resolution DTS with a 96 kHz sampling rate and 24-bit resolution, providing superior fidelity. Use it with DVDs that bear the DTS 96/24 logo.

### DTS-ES Discrete

This mode is for use with DTS-ES Discrete soundtracks, which use a discrete surround back channel for true 6.1/7.1-channel playback. The seven totally separate audio channels provide better spatial imaging and 360-degree sound localization, perfect for sounds that pan across the surround channels. Use it with DVDs that bear the DTS-ES logo, especially those with a DTS-ES Discrete soundtrack.

### DTS-ES Matrix

This mode is for use with DTS-ES Matrix soundtracks, which use a matrix-encoded back-channel for 6.1/7.1-channel playback. Use it with DVDs that bear the DTS-ES logo, especially those with a DTS-ES Matrix soundtrack.



### DTS Neo:6

This mode expands any 2-channel source for 6.1-channel playback. It uses six full-bandwidth channels of matrix decoding for matrix-encoded material, providing a very natural and seamless surround sound experience that fully envelops the listener.

- **Neo:6 Cinema**

Use this mode with any stereo movie (e.g., TV, DVD, VHS).

- **Neo:6 Music**

Use this mode with any stereo music source (e.g., CD, radio, cassette, TV, VHS, DVD).

### Dolby Digital + Neo:6

This mode uses Neo:6 to expand 5.1-channel Dolby Digital and DTS sources for 6.1/7.1-channel playback. Use it with DVDs that bear the Dolby Digital or DTS logo and feature a 5.1-channel soundtrack.



### Neural Surround

(TX-SR575 North American model only)

Neural Surround represents the latest advancement in surround technology developed for music and is adopted by XM Satellite Radio for digital radio broadcast of surround recordings and live events in surround sound. Neural Surround employs psychoacoustic frequency-domain processing, which allows delivery of a more detailed sound stage, with superior channel separation and localization of audio elements. System playback is scalable from 5.1 to 7.1 multichannel surround playback.

## Onkyo Original DSP Modes

### Mono Movie

This mode is suitable for old movies and other mono sources. The center speaker outputs the sound as it is, while reverb is applied to the sound output by the other speakers, giving presence to even mono material.

### Orchestra

Suitable for classical or operatic music, this mode emphasizes the surround channels in order to widen the stereo image, and simulates the natural reverberation of a large hall.

### Unplugged

Suitable for acoustic instruments, vocals, and jazz, this mode emphasizes the front stereo image, giving the impression of being right in front of the stage.

### Studio-Mix

Suitable for rock or pop music, listening to music in this mode creates a lively sound field with a powerful acoustic image, like being at a club or rock concert.

### TV Logic

This mode adds realistic acoustics to TV shows produced in a TV studio, surround effects to the entire sound, and clarity to voices.

### All Ch Stereo

Ideal for background music, this mode fills the entire listening area with stereo sound from the front, surround, and surround back speakers.

### Full Mono

In this mode, all speakers output the same sound in mono, so the sound you hear is the same regardless of where you are within the listening room.

### T-D (Theater-Dimensional)

With this mode, you can enjoy virtual 5.1 surround sound even with only two or three speakers. This works by controlling how sounds reach the listener's left and right ears. Good results may not be possible if there's too much reverb, so we recommend that you use this mode in an environment with little or no natural reverb.

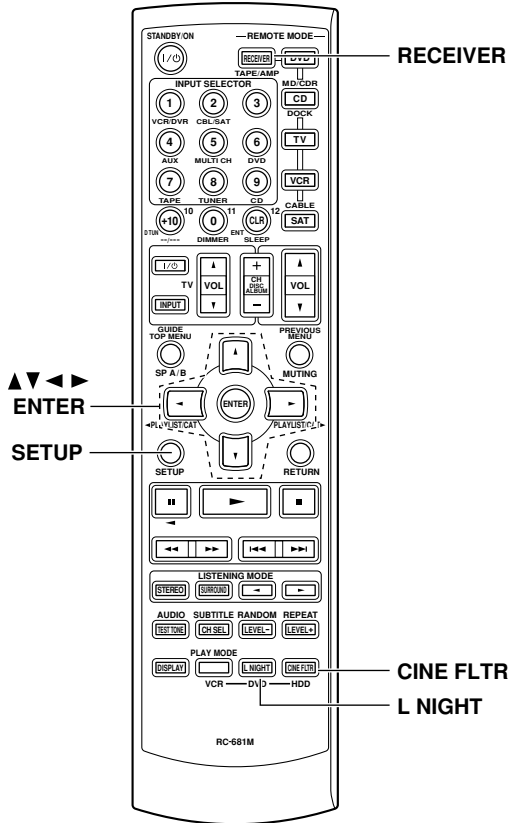

## Using the Late Night Function (Dolby Digital only)

With the Late Night function, you can reduce the dynamic range of Dolby Digital material so that you can still hear quiet parts even when listening at low volume levels—ideal for watching movies late at night when you don't want to disturb anyone.

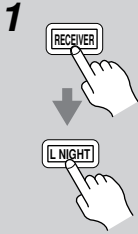
- 

**Press the [RECEIVER] REMOTE MODE button, and then press the [L NIGHT] button repeatedly to select:**

  - Off:** Late Night function off.
  - Low:** Small reduction in dynamic range.
  - High:** Big reduction in dynamic range.

### Notes:

- The effect of the Late Night function depends on the Dolby Digital material that you are playing, and with some material there will be little or no effect.
- The Late Night function is set to Off when the AV receiver is set to Standby.

## Using the CinemaFILTER

With the CinemaFILTER, you can soften overly bright movie soundtracks, which are typically mixed for reproduction in a movie theater.

CinemaFILTER can be used with the following listening modes: Dolby Digital, Dolby Digital EX, PLII/IIx Movie, DTS, DTS-ES, DTS Neo:6 Cinema, DTS 96/24, Dolby/DTS+PLIIx Movie, Dolby/DTS+Neo:6, and DTS+Dolby EX.

- 

**Press the [RECEIVER] REMOTE MODE button, and then press the [CINE FLTR] button repeatedly to select:**

  - On:** CinemaFILTER on.
  - Off:** CinemaFILTER off.

## Using the Audio Adjust Settings

The Audio Adjust settings only affect speaker set A.

- 

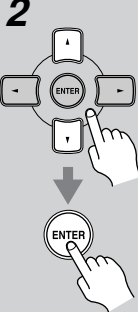
**Press the [RECEIVER] button followed by the [SETUP] button.**
- 

**Use the Up and Down [▲]/[▼] buttons to select "Audio Adjust," and then press [ENTER].**

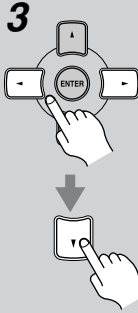
Audio Adjust
- 

**Use the Left and Right [◀]/[▶] buttons to change the setting. Press the Down [▼] button to select the next setting. Repeat this step for the other settings.**

4



**Press the [SETUP] button.**

Setup closes.

The Audio Adjust settings are explained below.

### **Input Channel Settings**

---

#### ■ **Multiplex**

This setting determines which channel is output from a stereo multiplex source. Use it to select audio channels or languages with multiplex sources, multilingual TV broadcasts, and so on.

**Main:** The main channel is output (default).

**Sub:** The sub channel is output.

**M/S:** Both the main and sub channels are output.

#### ■ **Mono Input Ch**

This setting determines which channel is output when the Mono listening mode is used with a stereo source.

**L+R:** Both the left and right channels are output (default).

**L:** Only the left channel is output.

**R:** Only the right channel is output.

### **PLII and PLIIX Music Mode Settings**

---

These settings apply to only 2-channel (stereo) sources.

#### ■ **Panorama**

With this setting, you can broaden the width of the front stereo image when using the Pro Logic II Music or Pro Logic IIX Music listening mode.

**On:** Panorama function on.

**Off:** Panorama function off (default).

#### ■ **Dimension**

With this setting, you can move the sound field forward or backward when using the Pro Logic II Music or Pro Logic IIX Music listening mode. The default value is 0. It can be adjusted from -3 to +3. Higher settings move the sound field forward. Lower settings move it backward.

If the stereo image feels too wide, or there's too much surround sound, move the sound field forward to improve the balance. Conversely, if the stereo image feels like it's in mono, or there's not enough surround sound, move it backward.

#### ■ **Center Width**

With this setting, you can adjust the width of the sound from the center speaker when using the Pro Logic II Music or Pro Logic IIX Music listening mode. Normally, the center channel sound is output by only the center speaker. (If you're not using a center speaker, the center channel sound will be distributed to the front left and right speakers to create a phantom center). This setting adjusts the front left, right, and center mix, allowing you to adjust the weight of the center channel sound. It can be adjusted from 0 to 7 (default value is 3).

### **DTS Neo:6 Music Mode Setting**

---

#### ■ **Center Image**

The DTS Neo:6 Music listening mode creates 6-channel surround sound from 2-channel (stereo) sources. With this setting, you can specify by how much the front left and right channel output is attenuated in order to create the center channel. It can be adjusted from 0 to 5 (default value is 2). This setting has no effect if no center speaker is connected.

When set to 0, the front left and right channel output is attenuated by half (-6 dB), giving the impression that the sound is located centrally. This setting works well when the listening position is considerably off center. When set to 5, the front left and right channels are not attenuated, maintaining the original stereo balance.

### **Dolby Digital EX Input Signal Setting**

---

#### ■ **Dolby EX**

This setting determines how Dolby Digital EX signals are handled. This setting is unavailable if no surround back speakers are connected or speaker set B is on.

**Auto:** If the source signal contains a Dolby Digital EX flag, the Dolby Digital EX listening mode is used (default).

**Manual:** You can select Pro Logic IIX Movie, Pro Logic IIX Music, Dolby Digital, or Dolby Digital EX.

### ***T-D Listening Angle Setting***

---

#### ■ **Lstn Angl (Listening Angle)**

With this setting, you can specify the angle of the front left and right speakers relative to the listening position. Processing for the Theater-Dimensional listening mode is based on this setting. Ideally, the front left and right speakers should be equidistant from the listening position and at an angle close to one of the three available settings.

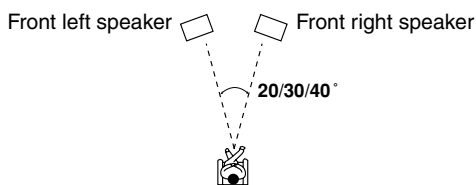

**Narrow:** Select if the listening angle is 20 degrees.

**Middle:** Select if the listening angle is 30 degrees (default).

**Wide:** Select if the listening angle is 40 degrees.

### ***Multichannel Subwoofer Setting***

---

#### ■ **SW Sens**

On some DVD players, the signal from the multichannel subwoofer output is 15 dB higher than normal. You can change the subwoofer sensitivity to match your DVD player. Note that this setting only affects signals connected to the SUBWOOFER input jack of the multichannel DVD input.

You can select 0 dB (default), +5 dB, +10 dB, or +15 dB. If you find that your subwoofer is too loud, try the +10 dB or +15 dB setting.

# Recording

This section explains how to record the selected input source to a component with recording capability, and how to record audio and video from different sources.

## Recording the Input Source

You can only record to a component that's connected to the TAPE OUT or VCR/DVR OUT jacks.

See pages 22–33 for information on connecting your AV components.

<p><b>1</b></p> <p>Remote controller</p>	<p><b>Use the input selector buttons to select the component that you want to record.</b></p> <p>Audio signals from the selected input source are output by the TAPE OUT and VCR/DVR OUT jacks.</p> <p>You can listen to the source while recording. The AV receiver's VOLUME control has no effect on recording.</p>
<p><b>2</b></p>	<p><b>On your recorder, start recording.</b></p>
<p><b>3</b></p>	<p><b>Start playback on the source component.</b></p>

### Notes:

- You cannot record from a component that's connected to a digital input. Only analog inputs can be recorded.
- The surround sound effects provided by the listening modes cannot be recorded.
- You cannot record from a component that's connected to the multichannel DVD input.
- If you select another input source while recording, that input source will be recorded instead.
- While the Pure Audio listening mode is selected, the VCR/DVR OUT V and S jacks don't output video signals, so select another mode when recording.

## Recording Audio and Video from Separate Sources

You can overdub audio onto your video recordings by simultaneously recording audio and video from two separate sources. This is possible because only the audio source is switched when an audio-only input source, such as TAPE, TUNER, or CD, is selected, the video source remains the same.

In the following example, audio from the CD player connected to the CD IN jacks, and video from the camcorder connected to the AUX INPUT VIDEO jack are recorded by the VCR connected to the VCR/DVR OUT jacks.

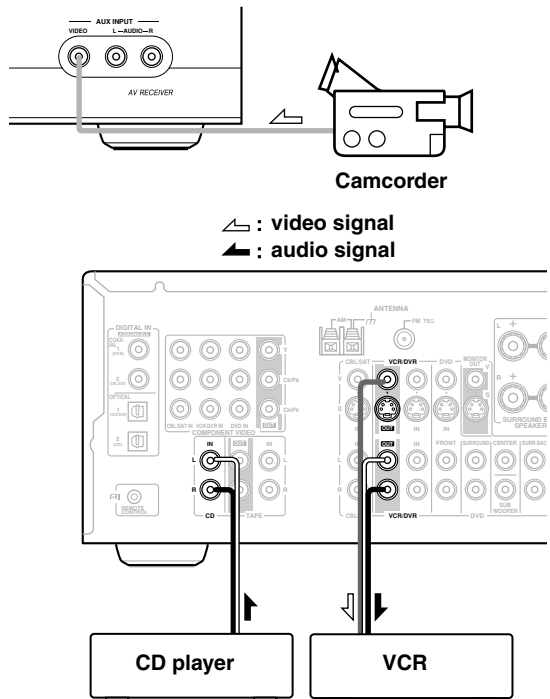

- 1. Prepare the camcorder and CD player for playback.**
- 2. Prepare the VCR for recording.**
- 3. Press the [AUX] input selector button.**
- 4. Press the [CD] input selector button.**  
This selects the CD player as the audio source, but leaves the camcorder as the video source.
- 5. Start recording on the VCR, then start playback on the camcorder and CD player.**  
Video from the camcorder and audio from the CD player are recorded by the VCR.

# Advanced Setup

## Advanced Speaker Settings

This section explains how to check the speaker settings and how to set them manually, which is useful if you change a speaker after performing the automatic speaker setup.

Some speaker settings are set automatically by the Automatic Speaker Setup function (see page 35).

### Speaker Configuration

These settings are set automatically by the Automatic Speaker Setup function (see page 35).

This section explains how to specify which speakers are connected and their sizes.

For speakers with a cone diameter larger than 6-1/2 inches (16 cm), specify **Large** (full band). For those with a smaller diameter, specify **Small** (default crossover 100 Hz).

The crossover frequency can be changed on page 57.

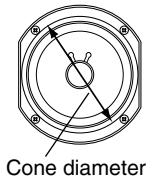

<p><b>1</b></p>	<p>Press the [RECEIVER] button followed by the [SETUP] button.</p>
<p><b>2</b></p>	<p>Use the Up and Down [▲]/[▼] buttons to select “Sp Config,” and then press the [ENTER] button.</p> <div style="border: 1px solid black; padding: 5px; width: fit-content; margin: 10px auto;">Sp Config</div>
<p><b>3</b></p>	<p>While the Subwoofer setting is selected, use the Left and Right [◀]/[▶] buttons to select <b>Yes</b> or <b>No</b>.</p> <p><b>Yes:</b> Select if a subwoofer is connected.</p> <p><b>No:</b> Select if no subwoofer is connected.</p>

<p><b>4</b></p>	<p>Use the Down [▼] button to select “Front,” and then use the Left and Right [◀]/[▶] buttons to select <b>Small</b> or <b>Large</b>.</p> <p><b>Small:</b> Select if the front speakers are small.</p> <p><b>Large:</b> Select if the front speakers are large.</p> <p><b>Note:</b></p> <ul style="list-style-type: none"> <li>If the Subwoofer setting in step 3 is set to No, this setting is fixed at Large and does not appear.</li> </ul>
<p><b>5</b></p>	<p>Use the Down [▼] button to select “Center,” and then use the Left and Right [◀]/[▶] buttons to select <b>Small</b>, <b>Large</b>, or <b>None</b>.</p> <p><b>Small:</b> Select if the center speaker is small.</p> <p><b>Large:</b> Select if the center speaker is large.</p> <p><b>None:</b> Select if no center speaker is connected.</p> <p><b>Note:</b></p> <ul style="list-style-type: none"> <li>If the Front setting in step 4 is set to Small, the Large option cannot be selected.</li> </ul>
<p><b>6</b></p>	<p>Use the Down [▼] button to select “Surround,” and then use the Left and Right [◀]/[▶] buttons to select <b>Small</b>, <b>Large</b>, or <b>None</b>.</p> <p><b>Small:</b> Select if the surround speakers are small.</p> <p><b>Large:</b> Select if the surround speakers are large.</p> <p><b>None:</b> Select if no surround speakers are connected.</p> <p><b>Note:</b></p> <ul style="list-style-type: none"> <li>If the Front setting in step 4 is set to Small, the Large option cannot be selected.</li> </ul>



7

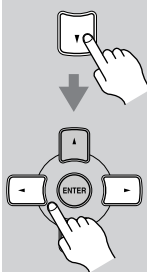

Use the Down [▼] button to select “Surr Back,” and use the Left and Right [◀]/[▶] buttons to select **Small**, **Large**, or **None**.

**Small:** Select if the surround back speakers are small.

**Large:** Select if the surround back speakers are large.

**None:** Select if no surround back speakers are connected.

**Notes:**

- If the Surround setting in step 6 is set to None, this setting does not appear.
- If the Surround setting in step 6 is set to Small, the Large option cannot be selected.

8

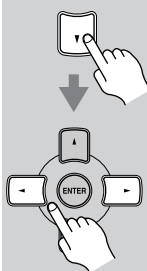

Use the Down [▼] button to select “Surr Back Ch,” and use the Left and Right [◀]/[▶] buttons to select **2ch** or **1ch**.

**2ch:** Select if two (left and right) surround back speakers are connected.

**1ch:** Select if one surround back speaker is connected.

**Note:**

- If the Surround and Surr Back settings in steps 6 and 7 are set to None, this setting does not appear.

Continue with step 9 of the “Crossover Frequency” setting.

**Note:**

- These settings cannot be changed while headphones are connected, speaker set B is on, or the multichannel DVD input is being used.

## Crossover Frequency

This setting is set automatically by the Automatic Speaker Setup function (see page 35).

This setting only applies to the speakers that you specified as *Small* in the “Speaker Configuration” on page 56. To get the best bass performance from your speaker system, you need to set the crossover frequency according to the size and frequency response of your speakers

9

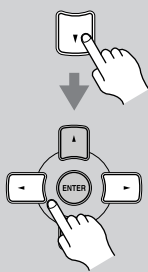

Use the Down [▼] button to select “Crossover,” and then use the Left and Right [◀]/[▶] buttons to select a crossover frequency.

Use the diameter of the smallest speaker in your system when choosing the crossover frequency.

Speaker cone diameter	Crossover frequency
Over 8 in. (20 cm)	40/50/60Hz*
6-1/2 to 8 in. (16–20 cm)	80Hz
5-1/4 to 6-1/2 in. (13–16 cm)	100Hz (default)
3-1/2 to 5-1/4 in. (9–13 cm)	120Hz
Under 3-1/2 in. (9 cm)	150/200Hz*

\*Choose the setting suitable for the speaker.

Continue with step 10 of the “Double Bass” setting on the next page.

**Notes:**

- For a more accurate setting, look up the frequency response in the manuals supplied with your speakers and set accordingly.
- Choose a higher crossover frequency if you want more sound from your subwoofer.
- These settings cannot be changed while headphones are connected, speaker set B is on, or the multichannel DVD input is being used.

### Double Bass

This setting is **not** set automatically by the Automatic Speaker Setup function (see page 35).

With the Double Bass function, you can boost bass output by feeding bass sounds from the front left and right channels to the subwoofer. This function can be set only if the Subwoofer setting (step 3) is set to Yes, and the Front setting (step 4) is set to Large in the Speaker Configuration on page 56.

<b>10</b>	<p>Use the Down [▼] button to select “Double Bass,” and then use the Left and Right [◀]/[▶] buttons to select:</p> <p><b>On:</b> Double Bass function on. Bass from the front left and right channels is also fed to the subwoofer (default).</p> <p><b>Off:</b> Double Bass function off.</p>
<b>11</b>	<p>Press the [SETUP] button. Setup closes.</p>

**Note:**

- These settings cannot be changed while headphones are connected, speaker set B is on, or the multichannel DVD input is being used.

### Speaker Distance

These settings are set automatically by the Automatic Speaker Setup function (see page 35).

With these settings, you can specify the distance from each speaker to the listening position.

<b>1</b>	<p>Measure and make a note of the distance from each speaker to the listening position.</p>
<b>2</b>	<p>Press the [RECEIVER] REMOTE MODE button, followed by the [SETUP] button.</p>
<b>3</b>	<p>Use the Up and Down [▲]/[▼] buttons to select “Sp Distance,” and then press [ENTER].</p> <div style="border: 1px solid black; padding: 5px; text-align: center; margin-top: 10px;">Sp Distance</div>
<b>4</b>	<p>While “Unit” is displayed, use the Left and Right [◀]/[▶] buttons to select “feet” or “meters”.</p> <p><b>feet:</b> Distances can be set in feet. Range: 1 to 30 feet in 1-foot steps.</p> <p><b>meters:</b> Distances can be set in meters. Range: 0.3 to 9 meters in 0.3-meter steps.</p>
<b>5</b>	<p>Use the Down [▼] button to select “Front,” and use the Left and Right [◀]/[▶] buttons to specify the distance for the front speakers, then press the Down [▼] button to select the next speaker.</p>
<b>6</b>	<p>Repeat step 5 for all speakers.</p> <p><b>Note:</b> Speakers that you set to No or None in the Speaker Configuration (page 56) cannot be selected.</p>

**7**



**Press the [SETUP] button.**

Setup closes.

### Notes:

- The Center and Subwoofer distances can be set up to 5 ft. (1.5 m) more or less than the Front distance. For example, if the Front distance is set to 20 ft. (6 m), the Center and Subwoofer distances can be set between 15 and 25 ft. (4.5 and 7.5 m).
- The Surround and Surround Back distances can be set up to 5 ft. (1.5 m) more or 15 ft. (4.5 m) less than the Front distance. For example, if the Front distance is set to 20 ft. (6 m), the SurrRight, Surr Left, Surr Back R, and Surr Back L distances can be set between 5 and 25 ft. (1.5 and 7.5 m).
- The speaker distance cannot be adjusted while a pair of headphones is connected, speaker set B is on, or the multichannel DVD input is being used.

### Speaker Levels

These settings are set automatically by the Automatic Speaker Setup function (see page 35).

You can set the volume level of each speaker so that all speakers can be heard equally at the listening position.

**1**



**Press the [RECEIVER] REMOTE MODE button, followed by the [SETUP] button.**

**2**

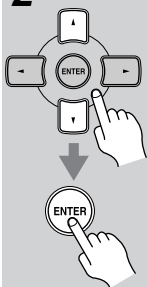

**Use the Up and Down [▲]/[▼] buttons to select “Level Cal,” and then press [ENTER].**

A pink noise test tone is output by the front left speaker.

Level Cal

**3**

**Turn up the volume so that you can hear the test tone sufficiently.**

As each speaker outputs the test tone, its name appears on the display.

Left : 0dB

**4**

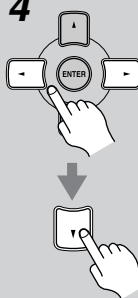

**Use the Left and Right [◀]/[▶] buttons to adjust the speaker level, and use the Down [▼] button to select the next speaker.**

The levels can be adjusted from -12 to +12 dB in 1 dB steps (-15 to +12 dB for the subwoofer).

**5**

**Repeat step 4 so that the level of the test tone coming from each speaker is the same.**

Speakers that you set to No or None in the Speaker Configuration (page 56) do not output the test tone.

**6**



**Press the [SETUP] button.**

Setup closes.

Don't forget to turn down the volume if you turned it up while setting the levels.



### Notes:



- A quick way to adjust the speaker levels is to press the remote controller's [TEST TONE] button to turn on the test tone, use the [LEVEL-] and [LEVEL+] buttons to adjust the levels, and use the [CH SEL] button to select the speakers.
- The speaker levels cannot be adjusted while a pair of headphones is connected, speaker set B is on, or the AV receiver is muted.

## Equalizer Settings

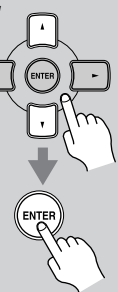
These settings are set automatically by the Automatic Speaker Setup function (see page 35).

Here you can adjust the tone of individual speakers. To set the volume of individual speakers, see page 59.

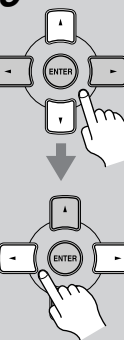
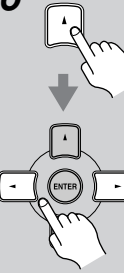
<p><b>1</b></p> 	<p>Press the [RECEIVER] REMOTE MODE button, followed by the [SETUP] button.</p>
<p><b>2</b></p> 	<p>Use the Up and Down [▲]/[▼] buttons to select “Equalizer,” and then press [ENTER].</p> <div style="border: 1px solid black; padding: 5px; text-align: center;">Equalizer</div>
<p><b>3</b></p> 	<p>Use the Left and Right [◀]/[▶] buttons to select:</p> <p><b>Off:</b> Tone off, response flat.</p> <p><b>Audyssey:</b> The tone for each speaker is set automatically by the Automatic Speaker Setup function. Be sure to select this setting after having performed the Automatic Speaker Setup.</p> <p><b>Manual:</b> You can adjust the equalizer for each speaker manually.</p> <p>If you selected Manual, continue with this procedure. If you selected Off or Audyssey, go to step 7.</p>
<p><b>4</b></p> 	<p>Press the Down [▼] button, and then use the Left and Right [◀]/[▶] buttons to select a speaker.</p> <div style="border: 1px solid black; padding: 5px; text-align: center;">Ch #Front</div>

<p><b>5</b></p> 	<p>Use the Up and Down [▲]/[▼] buttons to select a frequency. Use the Left and Right [◀]/[▶] buttons to adjust the level at that frequency.</p> <div style="border: 1px solid black; padding: 5px; text-align: center;">F 800Hz #+3dB</div> <p>The volume at each frequency can be adjusted from -6 to +6 dB in 1 dB steps.</p> <p><b>Tip:</b> Low frequencies (e.g., 80 Hz) affect bass sounds; high frequencies (e.g., 8000 Hz) affect treble sounds.</p>
<p><b>6</b></p> 	<p>Use the Up [▲] button to select “Ch,” and then use the Left and Right [◀]/[▶] buttons to select another speaker.</p> <p>Repeat steps 5 and 6 for each speaker. Speakers that you’ve set to No or None in the Speaker Configuration (page 56) cannot be selected.</p>
<p><b>7</b></p> 	<p>Press the [SETUP] button. The setup menu closes.</p>

### Notes:

- The front, center, surround, and surround back speakers can be adjusted at 80 Hz, 250 Hz, 800 Hz, 2500 Hz, and 8000 Hz. The subwoofer can be adjusted at 40 Hz, 80 Hz, and 160 Hz.
- While the Direct or Pure Audio listening mode is selected, the equalizer settings have no effect.
- This procedure can also be performed on the AV receiver by using its [SETUP], [ENTER], and arrow buttons.

## Digital Input Signal Formats

The following table shows the display indicator for each digital signal format.

Format	Display
Dolby Digital	D
DTS	
PCM	PCM

Normally, the AV receiver detects the signal format automatically. However, if you experience either of the following issues when playing PCM or DTS material, you can specify the signal format as either PCM or DTS:

- If the beginnings of tracks from a PCM source are cut off, try the PCM setting.
- If noise is produced when fast forwarding or reversing a DTS CD, try the DTS setting.

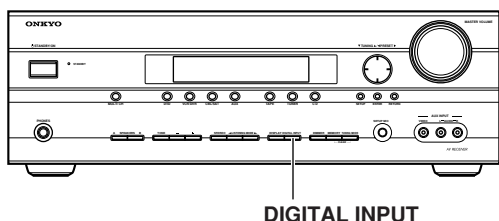

**1** Press and hold the AV receiver's [DIGITAL INPUT] button for about 3 seconds.

**2** While "Auto" is displayed (about 3 seconds), press the [DIGITAL INPUT] button repeatedly to select: PCM, DTS, or Auto.

**PCM:** Only PCM format input signals will be heard. If the input signal is not PCM, the PCM indicator will flash and there will be no sound.

**DTS:** Only DTS format input signals will be heard. If the input signal is not DTS, the DTS indicator will flash and there will be no sound.

**Auto (default):** The format is detected automatically. If no digital input signal is present, the corresponding analog input is used instead.

## Correcting Sound and Picture Sync

When using progressive scanning on your DVD player, you may find that the picture and sound are out of sync. With this setting, you can correct this by delaying the audio signals. You can set it from 0 to 100 milliseconds (ms) in 20 millisecond steps.

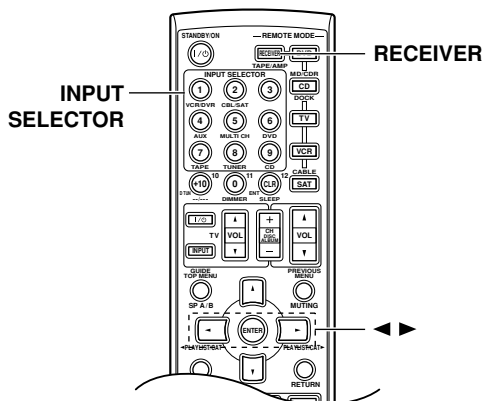

**1** Press the [RECEIVER] REMOTE MODE button.

**2** Press and hold, for more than 4 seconds, the input selector button for the input source that you want to correct. This can be the [DVD], [VCR/DVR], [CBL/SAT], or [AUX] input source.

**3** Use the Left and Right [◀/▶] buttons to adjust the delay from 0 to 100 milliseconds in 20 millisecond steps.

A/V Sync # 20ms

**Note:**

- This setting is not available when the Pure Audio listening mode is used, or the Direct listening mode is used with an analog input signal.

# Controlling Other Components

You can use the AV receiver's remote controller (RC-681M) to control your other AV components, including those made by other manufacturers. This section explains how to enter the necessary remote control code for the component that you want to control (e.g., DVD player, TV, or VCR).

## Entering Remote Control Codes

To control another component, you must first enter the appropriate remote control code to a REMOTE MODE button. You'll need to enter a code for each component that you want to control.

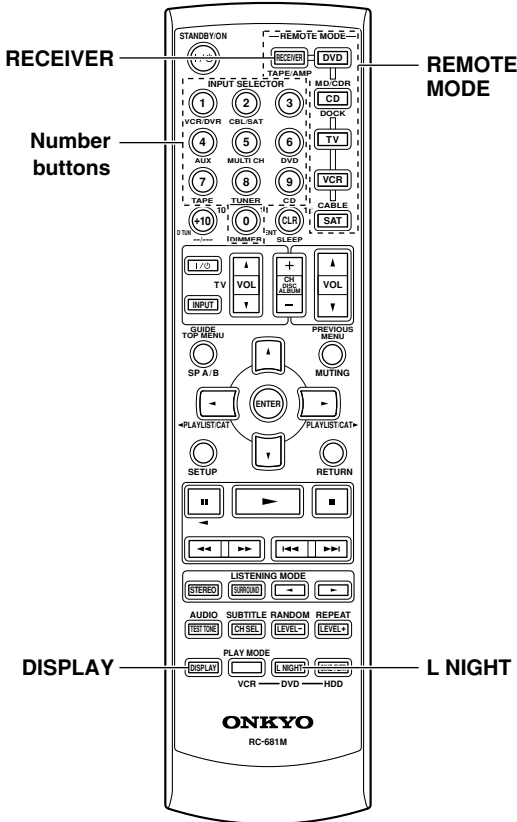

<b>1</b>	<p><b>Look up the appropriate remote control code in the separate Remote Control Codes list.</b></p> <p>The codes are organized by category (e.g., DVD player, TV, etc.).</p>
<b>2</b>	<p><b>While holding down the REMOTE MODE button that you want to set, press the [DISPLAY] button for 3 seconds.</b></p> <p>The REMOTE MODE button lights up.</p>
<b>3</b>	<p><b>Within 30 seconds, use the number buttons to enter the 4-digit remote control code.</b></p> <p>The REMOTE MODE button flashes twice.</p>
<b>4</b>	<p><b>Press the REMOTE MODE button again to select the remote controller mode, point the remote controller at the component, and check the operation.</b></p> <p>If the remote controller doesn't work as expected, and several remote codes are listed, try each one in turn and use the one that works best.</p>

### Notes:

- A remote control code cannot be entered for the [RECEIVER] REMOTE MODE button.
- The remote control codes provided are correct at the time of printing, but are subject to change.

### Remote Control Codes for Onkyo Components Connected via RI

Onkyo components that are connected via **RI** are controlled by pointing the remote controller at the AV receiver, not the component. This allows you to control components that are out of view, in a rack, for example.

- 1** Make sure the Onkyo component is connected with an **RI** cable and an analog audio cable (RCA).  
See page 33 for details.
- 2** Enter the appropriate remote control code for the [DVD] or [CD] REMOTE MODE button.  
[DVD] REMOTE MODE button  
**1612:** Onkyo DVD player with **RI**  
[CD/MD/CDR/DOCK] REMOTE MODE button  
**1327:** Onkyo CD player with **RI**  
**1808:** Onkyo MD recorder with **RI**  
**1322:** Onkyo CD recorder with **RI**  
**1993:** Onkyo RI Dock with **RI**  
See the previous page for how to enter remote control codes.
- 3** Press the [DVD] or [CD] REMOTE MODE button, point the remote controller at the AV receiver, and operate the component.

If you want to control an Onkyo component by pointing the remote controller directly at it, or you want to control an Onkyo component that's not connected via **RI**, use the following remote control codes:

- [DVD] REMOTE MODE button  
**0627:** Onkyo DVD player without **RI** (default)
- [CD/MD/CDR/DOCK] REMOTE MODE button  
**1817:** Onkyo CD player without **RI** (default)  
**0868:** Onkyo MD recorder without **RI**  
**1323:** Onkyo CD recorder without **RI**  
**2990:** Onkyo RI Dock without **RI**

#### Note:

If you connect an **RI**-capable Onkyo MD recorder, CD recorder, or RI Dock component to the TAPE IN/OUT or CBL/SAT jacks, for remote operation to work properly, you must set the Input Display to MD, CDR, or DOCK (see page 39).

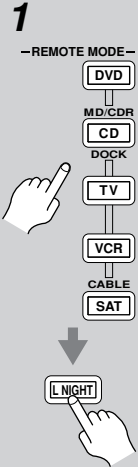
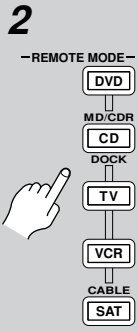

### Resetting REMOTE MODE Buttons

You can reset a REMOTE MODE button to its default remote control code.

- 1** While holding down the REMOTE MODE button that you want to reset, press the [L NIGHT] button for 3 seconds.  
The REMOTE MODE button lights up.  

- 2** Press the REMOTE MODE button again.  
The REMOTE MODE button flashes twice, indicating that it's been reset.  
The [DVD] and [CD] REMOTE MODE buttons are preprogrammed with remote control codes for controlling Onkyo DVD players and CD players respectively. When these buttons are reset, the preprogrammed code is restored.  

### Resetting the Remote Controller

You can reset the remote controller to its default settings.

- 1** While holding down the [RECEIVER] REMOTE MODE button, press the [L NIGHT] button for 3 seconds.  
The [RECEIVER] button lights up.  

- 2** Press the [RECEIVER] REMOTE MODE button again.  
The [RECEIVER] button flashes twice, indicating that it's been reset.  

## Controlling Other Components—Continued

To control another component, point the remote controller at it and use the buttons explained below. (You must select the appropriate remote control mode first.) With some AV components, certain buttons may not work as expected, and some may not work at all.

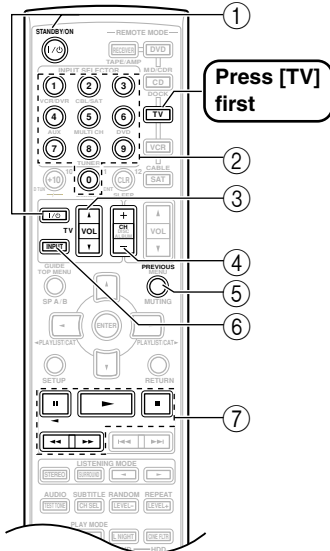
### ■ Controlling a TV



- ① **[STANDBY/ON], TV [⏻/⏻]\***  
Sets the TV to On or Standby.
- ② **Number buttons**  
Enter numbers.
- ③ **TV VOL [▲]/[▼]\***  
Adjusts the TV's volume.
- ④ **[CH +/-]**  
Selects channels on the TV.
- ⑤ **[PREVIOUS]**  
Selects the previous channel.
- ⑥ **[TV INPUT]\***  
Selects the TV's VCR input.
- ⑦ **[⏸], [▶], [⏹], [⏮], [⏭]**  
Operates the VCR.

\* Buttons marked with an asterisk (\*) are exclusively for controlling a TV and can be used at any time regardless of the current remote controller mode.

### ■ Controlling a VCR

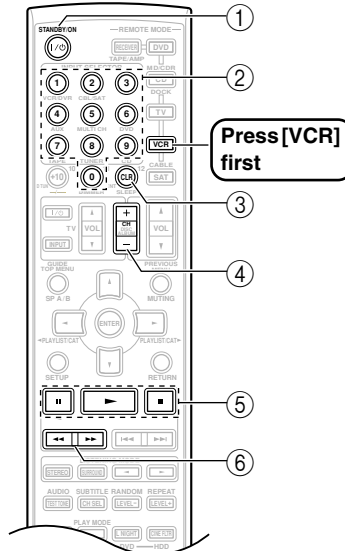

- ① **[STANDBY/ON]**  
Sets the VCR to On or Standby.
- ② **Number buttons**  
Select channels.
- ③ **[CLR]**  
Cancels functions.
- ④ **[CH +/-]**  
Selects channels on the VCR.
- ⑤ **[⏸], [▶], [⏹]**  
Pause, Play, Stop.
- ⑥ **[⏮], [⏭]**  
Rewind and Fast forward.

### ■ Controlling a Satellite or Cable Receiver

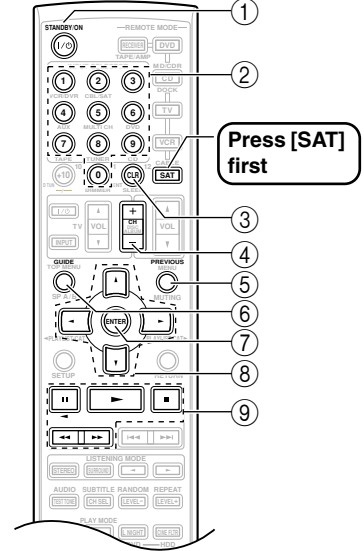

- ① **[STANDBY/ON]**  
Sets the satellite/cable receiver to On or Standby.
- ② **Number buttons**  
Enter numbers.
- ③ **[CLR]**  
Cancels functions.
- ④ **[CH +/-]**  
Selects satellite/cable channels.
- ⑤ **[PREVIOUS]**  
Selects the previous channel.
- ⑥ **[GUIDE]**  
Displays the program guide.
- ⑦ **[ENTER]**  
Confirms the selection.
- ⑧ **[▲]/[▼]/[◀]/[▶]**  
Selects menu items.
- ⑨ **[⏸], [▶], [⏹], [⏮], [⏭]**  
Operates the VCR.



# Troubleshooting

If you have any trouble using the AV receiver, look for a solution in this section.

If you can't resolve the issue yourself, try resetting the AV receiver before contacting your Onkyo dealer.

**To reset the AV receiver to its factory defaults, turn it on and, while holding down the [VCR/DVR] button, press the [STANDBY/ON] button. "Clear" will appear on the display and the AV receiver will enter Standby mode.**

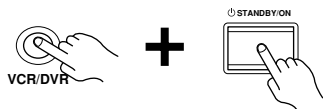

Note that resetting the AV receiver will delete your radio presets and custom settings.

## Power

### Can't turn on the AV receiver

- Make sure that the power cord is plugged into the wall outlet properly.
- Unplug the power cord from the wall outlet, wait 5 seconds or more, then plug it in again.

### The AV receiver turns off as soon as it's turned on

- The amp protection circuit has been activated. Remove the power cord from the wall outlet immediately. Disconnect all speaker cables and input sources, and leave the AV receiver with its power cord disconnected for 1 hour. After that, reconnect the power cord and set the volume to maximum. If the AV receiver stays on, set the volume to minimum, disconnect the power cord, and reconnect your speakers and input sources. If the AV receiver turns off when you set the volume to maximum, disconnect the power cord, and contact your Onkyo dealer.

## Audio

### There's no sound or it's very quiet

- Make sure that the digital input source is selected properly (page 39). Press the [DIGITAL INPUT] button repeatedly.
- Make sure the speaker set A or B is on (page 6).
- Make sure that all audio connecting plugs are pushed in all the way (page 22).
- Make sure that the polarity of the speaker cables is correct, and that the bare wire is in contact with metal part of each speaker terminal (page 19)
- Make sure that the speaker cables are not shorting.
- Check the volume. It can be set to MIN, 1 through 79, or MAX (page 40). The AV receiver is designed for home theater enjoyment and has a wide volume range for precise adjustment.

- If the MUTING indicator is shown on the display, press the remote controller's [MUTING] button to unmute the AV receiver (page 46).
- While a pair of headphones is connected, no sound is output by the speakers (page 47).
- Check the digital audio output settings on the connected device. On some games consoles, such as those that can play DVDs, the default setting is off.
- With some DVD-Video discs, you need to select an audio format from a menu.
- If your turntable doesn't have a phono preamp built-in, you must connect one between it and the AV receiver. If your turntable uses an MC cartridge, you must connect an MC head amp, or an MC transformer and a phono preamp.
- Make sure that the speaker setup microphone is not still connected.
- Specify the speaker distances and adjust the individual speaker levels (page 59).
- The input signal format is set to PCM or DTS. Set it to Auto (page 61).

### For TX-SR505 North American model/ TX-SR505E/TX-SR575 with HDMI

- Audio from a DVD player connected via HDMI is not output by the speakers connected to the AV receiver. To listen to this audio through the speakers, in addition to an HDMI connection, you'll also need to make a separate analog or digital audio connection (page 27).
- If your DVD player is connected via HDMI and your TV produces no sound, check your DVD player's audio output settings, and be sure to select an audio format that's supported by your TV.

### Only the front speakers produce sound

- When the Stereo or Mono listening mode is selected, only the front speakers and subwoofer produce sound.
- Make sure the speakers are configured correctly (page 56).

### Only the center speaker produces sound

- If you use the Pro Logic IIx Movie, Pro Logic IIx Music, or Pro Logic IIx Game listening mode with a mono source, such as an AM radio station or mono TV program, the sound is concentrated in the center speaker.
- Make sure the speakers are configured correctly (page 56).

### The surround speakers produce no sound

- When the Stereo or Mono listening mode is selected, the surround speakers produce no sound (page 50).
- Depending on the source and current listening mode, not much sound may be produced by the surround speakers. Try selecting another listening mode.

- Make sure the speakers are configured correctly (page 56).

### The center speaker produces no sound

- When the Stereo or Mono listening mode is selected, the center speaker produces no sound (page 50).
- Make sure the speakers are configured correctly (page 56).

### The surround back speakers produce no sound

- While speaker set B is on, speaker set A is reduced to 5.1-channel playback and the surround back speakers produce no sound.
- The surround back speakers are not used with all listening modes. Select another listening mode (page 50).
- Not much sound may be produced by the surround back speakers with some sources.
- Make sure the speakers are configured correctly (page 56).

### The subwoofer produces no sound

- The subwoofer outputs no sound while only speaker set B is on. Turn on speaker set A.
- When you play source material that contains no information in the LFE channel, the subwoofer produces no sound.
- Make sure the speakers are configured correctly (page 56).

### Speaker set B produces no sound

- Speaker set B only outputs sources that are connected to an analog input. Make sure that the analog audio cables are connected properly.

### There's no sound with a certain signal format

- Check the digital audio output setting on the connected device. On some games consoles, such as those that can play DVDs, the default setting is off.
- With some DVD-Video discs, you need to select an audio output format from a menu.

### Can't get 6.1- or 7.1-channel playback

- While speaker set B is on, speaker set A is reduced to 5.1-channel playback.

### The volume cannot be set to 79

- When the volume level of each speaker has been adjusted (pages 47, 59), the maximum possible volume may be reduced.

### Noise can be heard

- Using cable ties to bundle audio cables with power cords, speaker cables, and so on may degrade the audio performance, so don't do it.
- An audio cable may be picking up interference. Try repositioning your cables.

### The Late Night function doesn't work

- Make sure the source material is Dolby Digital (page 52).

### The multichannel DVD input doesn't work

- Check the multichannel DVD input connections (page 26).
- To select the multichannel DVD input, press the [MULTI CH] input selector button.
- Check the audio output settings on your DVD player.

### About DTS signals

- When playing DTS program material, using the pause, fast forward, or fast reverse function on your player may produce a short audible noise. This is not a malfunction.
- When DTS program material ends and the DTS bitstream stops, the AV receiver remains in DTS listening mode and the DTS indicator remains on. This is to prevent noise when you use the pause, fast forward, or fast reverse function on your player. If you switch your player from DTS to PCM, because the AV receiver does not switch formats immediately, you may not hear any sound, in which case you should stop your player for about 3 seconds, and then resume playback.
- With some CD players, you won't be able to playback DTS material properly even though your player is connected to a digital input on the AV receiver. This is usually because the DTS bitstream has been processed (e.g., output level, sampling rate, or frequency response changed) and the AV receiver doesn't recognize it as a genuine DTS signal. In such cases, you may hear noise.

## Video

### There's no picture

- Make sure that all video connecting plugs are pushed in all the way (page 22).
- Make sure that each video component is properly connected.
- **For TX-SR505/TX-SR505E/TX-SR8550:** The AV receiver does not convert between formats, so if a video source component is connected to a component video input, your TV must be connected to the component video output (page 23).
- **For TX-SR575:** If your video component is connected to a component video input, your TV must be connected to the component video output (page 23)
- **For TX-SR505 North American model/TX-SR505E/TX-SR575:** If a video component is connected to an HDMI input, your TV must be connected to the HDMI OUT (page 27).
- On your TV, make sure that the video input to which the AV receiver is connected is selected.

## Troubleshooting—Continued

- While the Pure Audio listening mode (not North American model) is selected, the video circuits are turned off and the AV receiver outputs no video signals.
- **For TX-SR505 North American model/ TX-SR505E/ TX-SR575:** Reliable operation with an HDMI-to-DVI adapter is not guaranteed. In addition, video signals from a PC are not supported (page 27).

### Tuner

#### Reception is noisy, stereo FM reception suffers from hiss, or the FM STEREO indicator doesn't appear

- Relocate your antenna.
- Move the AV receiver away from your TV or computer.
- Listen to the station in mono (page 42).
- When listening to an AM station, operating the remote controller may cause noise.
- Passing cars and airplanes can cause interference.
- Concrete walls weaken radio signals.
- If nothing improves the reception, install an outdoor antenna.

### Remote Controller

#### The remote controller doesn't work

- Make sure that the batteries are installed with the correct polarity (page 16).
- Make sure that the remote controller is not too far away from the AV receiver, and that there's no obstruction between the remote controller and the AV receiver's remote control sensor (page 16).
- Make sure you've selected the correct remote controller mode (page 12).
- Make sure you've entered the correct remote control code (page 62).

#### Can't control other components

- Make sure you've selected the correct remote controller mode (page 12).
- If you've connected an **RI**-capable Onkyo MD recorder, CD recorder, or RI Dock to the TAPE IN/OUT jacks or CBL/SAT jacks, for the remote controller to work properly, you must set the Input Display to MD, CDR, or DOCK (page 39).
- The entered remote control code may not be correct. If more than one code is listed, try each one.
- With some AV components, certain buttons may not work as expected, and some may not work at all.
- To control an Onkyo component that's connected via **RI**, point the remote controller at the AV receiver. Be sure to enter the appropriate remote control code first (page 62).

- To control an Onkyo component that's not connected via **RI**, or another manufacturer's component, point the remote controller at the component. Be sure to enter the appropriate remote control code first (page 62).

### Recording

#### Can't record

- On your recorder, make sure the correct input is selected.
- To prevent signal loops and damage to the AV receiver, input signals are not fed through to outputs with the same name (e.g., TAPE IN to TAPE OUT, or VCR/DVR IN to VCR/DVR OUT).
- When the Pure Audio listening mode is selected, recording is not possible because no video signals are output. Select another listening mode.

### Others

#### The sound changes when I connect my headphones

- When a pair of headphones is connected, the listening mode is set to Stereo, unless it's already set to Stereo, Mono, Direct, or Pure Audio (not North American model).

#### The display doesn't work

- The display is turned off when the Pure Audio (not North American model) listening mode is selected.

#### How do I change the language of a multiplex source

- Use the "Multiplex" setting on the "Audio Adjust" menu to select Main or Sub (page 53).

#### The **RI** functions don't work

- To use **RI**, you must make an **RI** connection and an analog audio connection (RCA) between the component and AV receiver, even if they are connected digitally (page 33).

#### During automatic speaker setup, measurement fails and the message "Noise Error!" appears

- This can be caused by a speaker malfunction. Make sure all of your speakers are working properly.

The AV receiver contains a microcomputer for signal processing and control functions. In very rare situations, severe interference, noise from an external source, or static electricity may cause it to lockup. In the unlikely event that this happens, unplug the power cord from the wall outlet, wait at least five seconds, and then plug it back in again.

Onkyo is not responsible for damages (such as CD rental fees) due to unsuccessful recordings caused by the unit's malfunction. Before you record important data, make sure that the material will be recorded correctly.

Before disconnecting the power cord from the wall outlet, set the AV receiver to Standby.

### **Memory Backup**

The AV receiver uses a battery-less memory backup system in order to retain radio presets and other settings when it's unplugged or in the case of a power failure. Although no batteries are required, the AV receiver must be plugged into an AC outlet in order to charge the backup system. Once it has been charged, the AV receiver will retain the settings for several weeks, although this depends on the environment and will be shorter in humid climates.

# Specifications

## Amplifier Section

Rated Output Power (FTC)	
All channels:	<b>75 watts minimum continuous power per channel, 8 ohm loads, 2 channels driven from 20 Hz to 20 kHz, with a maximum total harmonic distortion of 0.08% (TX-SR505/TX-SR505E/TX-SR8550)</b> <b>80 watts minimum continuous power per channel, 8 ohm loads, 2 channels driven from 20 Hz to 20 kHz, with a maximum total harmonic distortion of 0.08% (TX-SR575)</b> <b>100 watts minimum continuous power per channel, 6 ohm loads, 2 channels driven at 1 kHz, with a maximum total harmonic distortion of 0.1%</b>
Rated Output Power (IEC)	7 ch × 130 W at 6 ohms, 1 kHz, 1 ch driven
Maximum Output Power (JEITA)	7 ch × 160 W at 6 ohms, 1 kHz, 1 ch driven
Dynamic Power	180 W (3Ω, 1 ch driven) 160 W (4Ω, 1 ch driven) 100 W (8Ω, 1 ch driven)
THD (Total Harmonic Distortion)	0.08% (Power Rated)
Damping Factor	60 (Front, 1kHz, 8Ω)
Input Sensitivity and Impedance	200 mV/ 47 kΩ (LINE)
Output Level and Impedance	200 mV/ 470 Ω (REC OUT)
Frequency Response	5 Hz–100 kHz/ +1 dB–3 dB (Direct mode)
Tone Control	±10 dB, 50 Hz (BASS) ±10 dB, 20 kHz (TREBLE)
Signal to Noise Ratio	100 dB (LINE, IHF-A)
Speaker Impedance	North American: 6Ω–16Ω Others: 4Ω–16Ω or 6Ω–16Ω

## Video Section

Input Sensitivity/Output Level and Impedance	1 V <sub>p-p</sub> /75Ω (Component and S-Video Y) 0.7 V <sub>p-p</sub> /75Ω (Component P <sub>B</sub> /C <sub>B</sub> , Pr/C <sub>R</sub> ) 0.28 V <sub>p-p</sub> /75Ω (S-Video C) 1 V <sub>p-p</sub> /75Ω (Composite)
Component Video	
Frequency Response	5 Hz – 50 MHz

## Tuner Section

FM Tuning Frequency Range	North American: 87.5 MHz– 107.9 MHz Other: 87.5 MHz– 108.0 MHz
AM Tuning Frequency Range	North American: 530 kHz–1710 kHz European: 522 kHz–1611 kHz Others: 522/530 kHz–1611/1710 kHz
Radio Presets	40

## General

Power Supply	North American: AC 120 V, 60 Hz European: AC 230 V, 50 Hz Others: AC 120/220–240 V, 50/60 Hz AC 220 V, 50/60 Hz
Power Consumption	North American: 4.9 A European: 570 W Others: 510 W 560 W
Standby Power Consumption	North American: 0.1 W European: 0.2 W Others: 0.5 W
Dimensions (W × H × D)	435 × 150 × 377 mm 17-1/8" × 5-7/8" × 14-13/16"
Weight	North American: 9.5 kg 20.9 lbs. Models with voltage selector: 10.5 kg 23.1 lbs. Others: 10.2 kg 22.5 lbs.

### ■ Video Inputs

HDMI	IN1, IN2 (TX-SR505 North American model/TX-SR505E/TX-SR575)
Component	TX-SR575: IN1, IN2, IN3 Others: DVD, VCR/DVR, CBL/SAT
S-Video	DVD, VCR/DVR, CBL/SAT
Composite	DVD, VCR/DVR, CBL/SAT, AUX

### ■ Video Outputs

HDMI	OUT (TX-SR505 North American model/TX-SR505E/TX-SR575)
Component	OUT
S-Video	MONITOR, VCR/DVR
Composite	MONITOR, VCR/DVR

### ■ Audio Inputs

Digital Inputs	Optical: 2 Coaxial: 2
Analog Inputs	DVD (MULTICHANNEL), VCR/DVR, CBL/SAT, AUX, TAPE, CD
Multichannel Inputs	7.1 (DVD)

### ■ Audio Outputs

Analog Outputs	TAPE, VCR/DVR
Subwoofer Pre Outputs	1
Speaker Outputs	SP A (L, R, C, SL, SR, SBL, SBR) SP B (L, R)
Phones	1

Specifications and features are subject to change without notice.

# Memo

---

# Memo

---

## **ONKYO CORPORATION**

Sales & Product Planning Div. : 2-1, Nisshin-cho, Neyagawa-shi, OSAKA 572-8540, JAPAN  
Tel: 072-831-8023 Fax: 072-831-8124

### **ONKYO U.S.A. CORPORATION**

18 Park Way, Upper Saddle River, N.J. 07458, U.S.A.  
Tel: 201-785-2600 Fax: 201-785-2650 <http://www.us.onkyo.com/>

### **ONKYO EUROPE ELECTRONICS GmbH**

Liegnitzerstrasse 6, 82194 Groebenzell, GERMANY  
Tel: +49-8142-4401-0 Fax: +49-8142-4401-555 <http://www.eu.onkyo.com/>

### **ONKYO EUROPE UK Office**

Suite 1, Gregories Court, Gregories Road, Beaconsfield, Buckinghamshire, HP9 1HQ  
UNITED KINGDOM Tel: +44-(0)1494-681515 Fax: +44(0)-1494-680452

### **ONKYO CHINA LIMITED**

Unit 1&12, 9/F, Ever Gain Plaza Tower 1, 88, Container Port Road, Kwai Chung,  
N.T., HONG KONG Tel: 852-2429-3118 Fax: 852-2428-9039  
<http://www.ch.onkyo.com/>



I0701-1

SN 29344406

(C) Copyright 2007 ONKYO CORPORATION Japan. All rights reserved.

